

Innovation

Report

/ 2016-2018



We believe that innovation is a strategic variable that affects all business and activities. We are leaders in innovation within the energy sector. Our activities in this field include sustainable development, the promotion of renewable energies, automation, leveraging the opportunities offered by digitalisation, and a commitment to technologies and new business models.

Innovation at Iberdrola

What

Open and decentralised innovation based on **sustainable development, renewable energies and emerging technologies** as drivers of value creation and social contribution.

Who

Innovative ecosystem. Internal and external talent.

+ Employees

Network of **collaborators, suppliers technology experts, startups, universities.**



How

- › Disruptive technologies
- › New business models
- › Digitisation
- › Innovative culture

Where

On an **international level**, providing energy solutions to our clients worldwide and contributing to **the sustainable development of all countries** in which we operate.

Table of Contents

1. Overview	9
Governance Structure	10
2. Executive summary	13
R&D - Innovation, technology and digital transformation: priorities for the utility of the future.....	14
Recognition for Innovation at Iberdrola 2016-2018.....	18
3. Innovation strategy	21
Vision	21
Iberdrola Innovation Plan 2015-2017	22
Iberdrola Innovation Plan 2018-2022: “setting solid foundations for sustainable growth in the next decade”	26
4. R&D&I management benchmarks	29
R&D&I Management System.....	30
5. Culture of innovation and talent	35
Attracting external talent	36
Supporting internal talent	47
INNODAY 2018, our commitment to innovation and young talent	52
6. Innovative ecosystem: Entrepreneurship, start-ups and suppliers	61
Iberdrola Ventures - Perseo Start-Up programme and entrepreneurship.....	62
Supplier Innovation Programme.....	67
Other Initiatives	69
Collaboration with other universities.....	71

7. Digital transformation	75
Digital Roadmap 2016-2022	76
Technological Pillars of the Digital Transformation	78
Digital Initiatives	80
8. Innovation in products and services	87
Decentralised energy generation	89
Smart home	90
Customised energy plans	93
Smart and sustainable cities	97
9. R&D Projects	103
R&D+i in the Generation area	104
R&D+i in the Networks Area	124
R&D&i in the Renewables Area	155
R&D+i in the Retail Area	194
R&D+i in the IT Area	196
R&D+i in the Safety and Prevention Area	208
10. Annexes	215
Innovation Policy	216
Knowledge Management Policy	218
Public project funding	220

A letter from the chairman

In this context of the energy model transformation, innovation is a key strategic variable when it comes to facing the challenges of a sector which is destined to become increasingly more sustainable and efficient.

I am pleased to present to you a new edition of the Iberdrola Innovation Report, which describes the main initiatives and projects undertaken during the period 2016- 2018 in the field of research, development and innovation (R&D&i).

Thanks to a proactive strategy which cuts across all of the company's business units and geographical areas, Iberdrola is now the most innovative utility in Spain and the third most innovative in Europe, according to the European Commission's classification.

The company invests 250 million euros annually in R&D&i activities, a figure that has been doubled over the last ten years and mainly allocated to projects related to renewable energies, smart grids, digital transformation and the development of tailor-made solutions for our clients.

Our open, decentralised innovation model has allowed us to create an ecosystem that integrates employees, technology collaborators, industrial organisations and public institutions, value creation, the transfer of knowledge, the attraction of talent and the promotion of entrepreneurship.

Some of the major milestones reached in these three years include the launch of the Iberdrola Universities Programme. Through this programme Iberdrola strengthens its links with the academic world, including prestigious universities such as MIT - Massachusetts Institute of Technology, the Comillas Pontifical University, the University of Salamanca, the University of Strathclyde and the Monterrey Institute of Technology, as well as with young entrepreneurs.



Today, Iberdrola is the most innovative utility in Spain and the third most innovative in Europe.



For the second year in a row, Iberdrola has been included among the 12 main European corporates committed to open innovation.

At the same time, Iberdrola has continued to foster internal talent, generating a culture of innovation among its professionals, in order to identify new challenges and opportunities and remain at the forefront of our sector.

Between 2016 and 2018, the Group reaffirmed its commitment to the digital transformation by holding two Digital Summits, where it announced the most significant advances made in this field.

In addition, on 23 May 2018, the company held the first edition of the Innoday, the great event of the energy sector with INNOVATION, at the Iberdrola Campus. The most innovative initiatives in the energy sector were presented, both from our own businesses and from our collaborators and young

talents, highlighting the role of innovation as a promoter of social and economic progress.

Precisely because of our support for new business initiatives, Iberdrola has been included in 2018 for the second year in a row, among the 12 European corporates committed to open innovation promoted, being selected as one of the *Corporate Startup Stars* of the year and having received the Corporate Startup Procurement award.

These recognitions are an incentive to keep encouraging innovation and research. Throughout the next four years, Iberdrola will continue its efforts to consolidate its sustainable growth, conscious that innovation is a key factor for the sustainability, efficiency and competitiveness of our company.

Ignacio S. Galán
Chairman of Iberdrola





Overview

Governance Structure

The group of companies making up Iberdrola had operations in over 40 countries in 2018, with its most relevant activities in Spain, the United Kingdom, the United States of America, Mexico and Brazil. These companies are integrated in the Iberdrola Group (the “**Group**”) whose parent company, as defined by law, is Iberdrola, S.A. (the “**Company**”).

The corporate and governance structure of the Group is an essential part of the corporate governance system and comprises:

- a. The Company, set up as a holding entity whose main function is to act as the holder of the shares of the *subholding* companies.
- b. The *subholding companies* in turn comprise, in every country where the Group has activities, a combination of holdings in the parent companies of the energy businesses operating in that area. The Group also has a *subholding* company for the parent companies of the non-energy businesses operating in several countries.
- c. The parent companies of the businesses assume executive responsibilities in a decentralised manner, have the independence required to perform the ordinary and effective management of each business, and are also responsible for their day-to-day control.

This corporate governance structure, which is explained in detail in the *General Corporate Governance Policy* and in the *Policy Defining and Coordinating the Iberdrola Group and Foundations of Corporate Organisation*, both available on the corporate website, streamlines the making of ordinary management decisions depending on the parent companies of the businesses and allows proper coordination at the Group level through the supervisory functions exercised by the *subholding* companies and the Company itself.

The Group’s corporate governance model distinguishes and separates the functions of normal running and effective management from those of supervision and control, with the Company taking responsibility for establishing the policies and strategies of the Group and the *subholding* companies taking responsibility for implementing these policies, strategies and guidelines in the countries in which they operate.

In this way, the Company Board of Directors, as part of its mandate to design, evaluate and continuously review the corporate governance system, approved the *Innovation Policy* and the *Knowledge Management Policy*, which are each analysed in the Appendix.

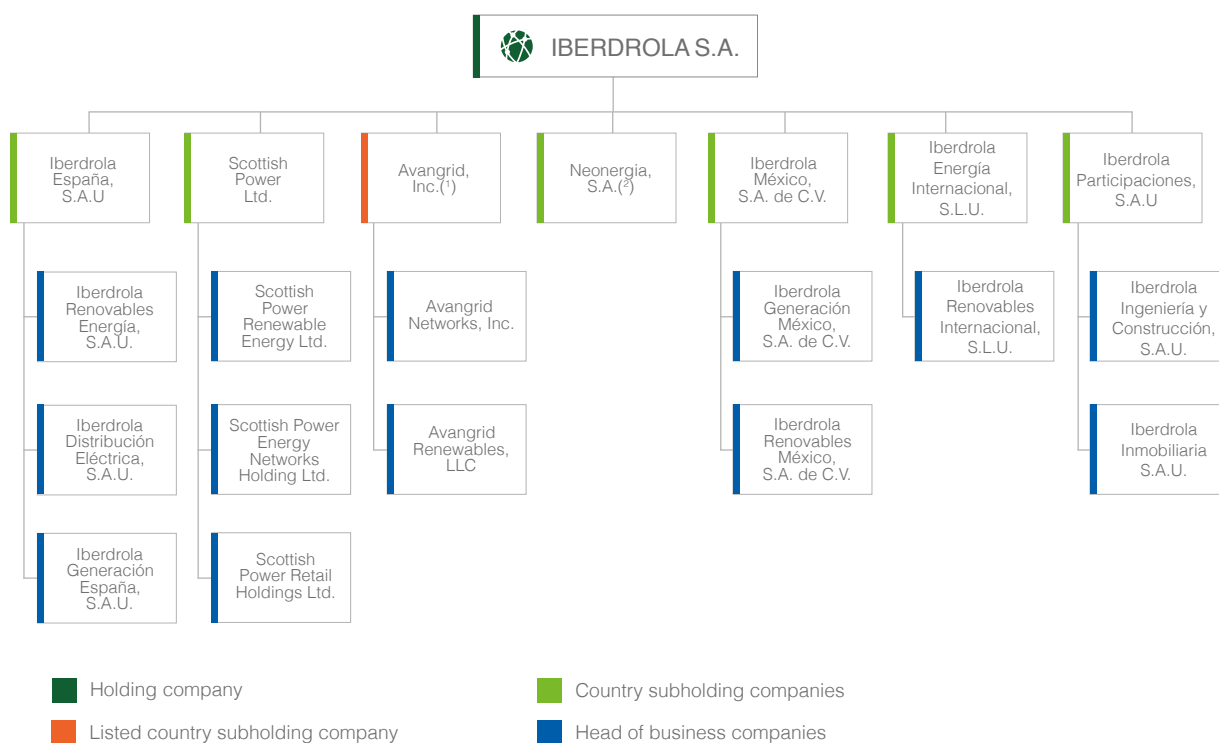





Executive summary

R&D - Innovation, technology and digital transformation: priorities for the utility of the future

Iberdrola is today a leading multinational group that has become the utility of the future thanks to its innovative strategy, which spans all of its business units and areas of activity. Thanks to the group's ongoing commitment to innovation, Iberdrola is now Spain's most innovative utility and the third in Europe, according to the European Commission's classification.

In 2018, Iberdrola invested in R&D a total of 267 million euros, 8% higher than in 2017. These resources have mainly been allocated to projects related to clean energies, smart grids, the development of custom solutions for customers, and the digital transformation

In the future, our commitment to innovation will be a priority to ensure sustainability, efficiency and competitiveness and keep Iberdrola at the forefront of the development of new products, services and business models that are transforming the sector:

- **Disruptive technologies**, which are increasingly more efficient, sustainable and respectful of the environment, that allow installations and processes to be optimized.
- **New products and services** respond to customer needs with more personalisation of content and offerings.
- **Digitisation and automation** in all businesses and processes to create value in the asset management lifecycle, network optimization and aggregation, and the design of integrated services for the new digital customer profile. The digital transformation will be based on new technologies such as blockchain, big data, IoT, virtual reality and artificial intelligence at all levels of the company.
- **Innovation with startups, entrepreneurs and suppliers.** We promote innovation with start-ups, entrepreneurs and suppliers in order to develop new business models, favouring the exchange of knowledge and acting as a tractor among our collaborators:
 - **The Iberdrola - Perseo Startup Programme** was created 10 years ago with a budget of €70m to promote the development of a dynamic ecosystem of startups and entrepreneurs in the electricity sector. For the second year in a row, Iberdrola has been recognised by the European Commission as being one of the European corporates that supports start-ups the most. In 2018, Iberdrola was named one of Europe's Top 12 Corporate Start-up Stars, the only Spanish company in the category, which recognises the continent's 12 corporate leaders. We also received our second special mention in the Start-up Procurement Award category for the technological pilots and purchases done with start-ups. As well as this recognition, last year the company became a shareholder in US company Innowatts, which focuses on developing artificial intelligence solutions for the electricity sector. Within the area of social investment, we have invested in the company Ilumexico, which brings electricity to rural areas of Mexico.
 - **Supplier innovation programme** focused on three areas: facilitating access to financing mechanisms, fostering the joint creation of companies (spin-offs with suppliers) and favouring innovative purchasing from small and medium-sized enterprises. This initiative gives us cutting-edge solutions which set us apart from our competitors while making our businesses more efficient. It also reinforces our role as a driving force behind the business in the locations where we operate and reinforce our commitment to innovation.

- **Innovation Culture and talent:** Iberdrola promotes a culture of innovation through the transfer of knowledge, the attraction of talent and the promotion of entrepreneurship.
 - › **Iberdrola Universities Programme.** The University Programme was launched in 2017 with the aim of attracting talent, transferring knowledge and contributing to society. As part of this programme, Iberdrola has signed agreements with the main universities in the countries where we are present: The University of Salamanca, the Comillas Pontifical University, MIT – *Massachusetts Institute of Technology*, the Monterrey Institute of Technology and the University of Strathclyde. The programme includes the following areas of action: chairs, R&D&i projects, training of students, internal training and young entrepreneurs. These include the following initiatives carried out with young entrepreneurs: MIT SANDBOX, Comillas *Emprende*, *Emprende Salamanca*, *Iberdrola- SP Entrepreneurial and Energy Business Model Challenge*. In total, in the last two years, 9 hackatons or bootcamps have been held with 1000 entrepreneurs and the collaboration of more than 200 mentors. More than 23 workshops have also been held and more than 2500 hours of *mentoring* have been provided. In addition, the new Smart Grid Master has been launched between the Comillas Pontifical University and the University of Strathclyde, in which Iberdrola collaborates actively.
 - › **Accelerator Project.** Through this initiative, Iberdrola uses in-house talent and the skills of its employees to identify the key factors that will allow us to become the world's biggest *utility* within 10 years. Between 2017 and 2018, the business of Renewables, Networks and Generation launched the initiatives *Renewables Accelerator Programme*, *Networks 2.0* and *Accelerator for Customer*, with the aim of satisfying the new demands of both the market and the business itself.

As a demonstration of its commitment to innovation, Iberdrola held the first edition of the **Innoday 2018 event** on May 23, on the company's international campus. The most innovative initiatives in the energy sector were presented, highlighting the role of innovation as the driver of social and economic progress.

Finally, Iberdrola has opened the 'Iberdrola Innovation Middle East Center' in Qatar, a technological center from which the company aims to develop innovation and consultancy services in three key areas: smart grids, system integration of renewable sources and energy efficiency.

Below are some of them classified by major areas:

Innovation in Renewables activities in 2018, similar to those of previous years, have mainly focused on:

Renewable energies

- **Improved efficiency in wind farms, photovoltaic plants and hydraulic installations.** Among these, should be highlighted the **Doctor PV project**, which seeks to reduce the costs of photovoltaic plants through predictive maintenance strategies, as well as the possible use of drones. Work has also continued on the **European project ROMEO**, coordinated by Iberdrola, and the **ASPA project**, which seek to develop models and tools for the early detection of faults based on artificial intelligence/big data techniques. The launch of the "**Renewables Digital Evolution Plan (2018 - 2022)**" and the "**Renewables Accelerator**" project for the promotion of new ideas that encourage increased efficiency and the global competitiveness of Renewables stand out. In Brazil, several projects are being developed for the implementation of solar energy. In Mexico, Iberdrola has built the Santiago photovoltaic facilities in San Luis Potosí and Hermosillo, in Sonora. In the area of hydraulic energy, the **HIDRODEMAND** project, aimed at implementing operational efficiencies, and the **HIDROSMART** project, for the development of new technologies for the operation of the Basin Operation Centres (COCs) are noteworthy.

- **Improving the integration of renewable energies.** Several initiatives have been carried out in the field of energy storage. In 2018, Avangrid Renewables has been registered as an independent **Balancing Authority** (BA), taking responsibility for balancing production and demand in real time. To this end, a 10MW/20MWh lithium ion battery will be incorporated. Projects are also being analyzed in the United States to hybridize energy storage in batteries with solar photovoltaic.
- **Innovation in offshore wind projects.** During 2018, the **Wikinger** offshore wind farm was inaugurated, and construction began on the **East Anglia One** offshore wind farm in the United Kingdom with an innovative design of foundations based on 3-leg jackets and cables connecting 66kV arrays. In addition, the effect of scour on the offshore foundations has continued to be analysed: **HasPRO** and **Sodercan-SPJ**.

Clean generation technologies

During 2018, efforts in the generation area focused on operational flexibility and efficiency, respect for the environment and the improvement of safety in facilities.

In the nuclear area, the **OFF-GAS**, **RESHAND** and **FILTRABRIS** projects stand out, which were developed in collaboration with GDEST4S within the framework of the Innovation Programme with Suppliers of Iberdrola, and all of them are oriented towards operational efficiency and nuclear safety.

In the area of thermal generation, and as a continuation of the **GT-CONTROLFLEX** project, the **OCTAVE** project stands out, which pursues the development of technologies for diagnosis and control of the combustion process that make our plants more flexible. Both projects are key to guaranteeing the robustness and safety of the Spanish electrical system, allowing the integration of renewables.

New products and services

Innovation is essential in commercial activity, in order to offer customers the products and services that best suit their needs. Thus, in 2018, Iberdrola has worked on:

- **New initiatives to improve the customer experience:** Throughout 2018, new campaigns and innovative projects were launched, focused on greater personalisation of content and offers, a new customer app in Spain, France and Portugal and a new website. In addition, it is now possible to make all contracts and purchases of products online, without prior registration.
- **New products and functionalities: Energy Wallet, Smart Home, Smart Solar and Smart Mobility.** Through the **Energy Wallet (Spain)** and **PowerUp (UK)** applications, customers can buy energy for months at a set price, choose how to pay for it and share it among all their homes. Everything is 100% digital (on the web and APP), easy and fast.

This year new Smart Home packs have been launched, combining energy, products and services, and devices aimed at improving energy management in the home for free. In addition, the functionalities of the **Smart Solar** have been improved, being able to obtain an “on-line offer” in the Public Web thanks to the analysis of the consumption curves, the expected insolation and the location and orientation of the installation. The web tool allows the monitoring of the production of the installation, with details of consumption, possible storage in batteries and demand of the network.

Within **Smart Mobility**, it is worth highlighting the launch of the new Iberdrola Public App Recharge, which makes it possible to reserve and use the recharge points of the Iberdrola network, and also the launch of the **Smart Mobility Home** application aimed at controlling household equipment recharges.

In Brazil, Neenergia has provided customers with a mobile application that allows them to consult their consumption, access invoices and manage their payments; and in the USA, Avangrid has launched **NYSEG Smart**, an online shop with which customers can search, compare and safely buy energy-efficient products (smart thermostats, lighting, EV chargers, etc.).

Smart grids

During 2018, Iberdrola continued to develop different R&D&I initiatives, both in Spain and Europe.

At European level, Iberdrola continues to participate in the **ASSURED** project, whose objective is to develop solutions for the rapid recharging of heavy-duty electric vehicles, and in the **INTENSIS4EU** project, which seeks a new approach in the field of the smart grid and energy storage. The **STAR+ project** will continue to digitize the network to improve efficiency and prepare Iberdrola as the future distribution system operator (DSO).

In Spain, Iberdrola will continue to drive the digital transformation of the Basque Country's electricity distribution network through the **Bidelek 4.0 project**. The **LAYCA** project continues, which seeks to develop a system for fault location and fault characterization in medium voltage networks. The **ALOIS** project has been initiated to develop a control and protection system for feeders for a stable and sustainable island operation. **mGRIDSTORAGE** is developing an advanced micro-network model with storage for distribution networks. The **Caravaca BESS** project has been launched with the objective of achieving the integration of a functioning battery energy storage system (BESS). In addition, work continues on new analytical models for the detection of non-technical losses. Finally, **CARTOLIDAR** has improved the inventory of lines and obtained a mapping of the vegetation around the power lines.

In the United Kingdom, development continues on the **Fusion** and **LV Engine** projects, both aimed at optimising low-voltage networks that present some of the most significant opportunities and challenges in moving towards a more flexible system. Also noteworthy is the **SPEN** project, designed to manage restrictions on the high voltage grid at the Dumfries and Galloway power plants.

In Brazil, the **BID MONITOR** project, which develops a decision support system for electricity sales, and the **Smart City**, for the implementation of innovative solutions for the automation and operation of the electricity grid, stand out. In addition, projects are being developed in isolated micro-networks. The **TI-TAM-BT** project pursues the development of equipment to reduce fraud and ensure proper billing to customers. Finally, the **Qliente** project aims to improve customer service by increasing the efficiency and flexibility of the call centre, reducing the time required to restore service and resolve complaints.

In the United States, the **Woodbridge Microgrid** project to develop a micro fuel cell network in Woodbridge (Connecticut), which will be operated in island mode under critical loads with the aim of strengthening the network in extreme weather conditions, is noteworthy. In addition, the initiatives included in the **Energy Smart Community (ESC)** programme have continued, such as the ADMS project, which aims to develop an advanced management system for the distribution system and distributed resources. On the other hand, drones have been used to carry out pilot inspections of Transmission assets and Substations with excellent results.

In 2018, the '*Iberdrola Innovation Middle East*' was inaugurated, a technology centre aimed at responding to the challenges of digitising the energy system, from where the company will develop new innovation and technology advisory services, focusing on three key areas: smart grids, integration of renewables and energy efficiency. Located in the facilities of '*Qatar Science & Technology Park*', Qatar's unique technological hub, its objective is to create new products and services for the digital *utility*, working at the intersection of information technologies and communication with energy.

IT

The IT area continued to bet on the development of innovative projects that allow the different areas of the company to create value, allowing them to achieve a competitive advantage in the market and increase their productivity and efficiency in all the geographical areas where they are present.

Among the **most outstanding IT projects in 2018**, are the corporate completion of the SAP HANA version, the continuation of the development of the new GIS system (Geographic Information System) of Distribution, and the start of the development of the new Big Data platform also in Distribution. Also in the United States, the “*Digital Customer Journey*” project has begun, which brings together several initiatives to enhance the digital experience of Avangrid’s customers, where the development of a solution to improve tax management and the consolidation in Orange County of all Avangrid’s data centers has also been completed. This initiative is similar to the one developed by Neoenergia in Brazil, where the project for the construction of the new Data Center in Salvador de Bahia has also been launched, along with various security improvements in the current facilities. For its part, in collaboration between the USA, the UK and Spain in 2018, the project for the development of the monitoring and follow-up system for the world energy markets was initiated. In Scotland, the programme for the deployment of smart meters has continued, and in Mexico, the development of the integral management system for generation assets.

At the same time, IT continues to promote the **development of innovation proof of concept** in different geographies and businesses, many of which are based on technologies such as augmented reality, the internet of things, *machine learning*, predictive analytics and voice recognition systems.

Recognition for Innovation at Iberdrola 2016-2018

Our unwavering commitment to innovation has earned Iberdrola acclaim through the following awards in 2016-2018:

- **Corporate Startup Stars 2018 and Corporate Startup Procurement.** For the second year in a row, Iberdrola has been included in the top 12 European corporates committed to open innovation promoted by the European Commission Europe Partnership.
- **Most innovative utility:** Iberdrola has been recognised as the most innovative Spanish utility and the third in Europe according to the European Commission's 2017 R&D Scorecard.
- **2017 Digital Disruption Award.** ComputerWorld magazine recognised the company for its project on corporate network visualisation for test environments.
- **European Digital Mindset Awards:** Award to the best company in digital transformation, for the European Digital Mindset Awards, organised within the framework of the DES2017 congress, as the company that has best executed the change from the traditional business model to the digital business.
- **CIONET International:** Our chief information officer, Fernando Lucero, was chosen as 2017 CIO of the year.
- **European Commission Europe’s Corporate Startup Stars 2017.** With Perseo, the company was included in the Europe’s Corporate Startup Stars 2017 awards, which highlight the companies that best collaborate with start-ups throughout Europe.
- **SEP Corporate Startup Procurement Award,** managed by the open innovation advisory firm Mind the Bridge and global innovation foundation Nesta.

- **Digital Era 2016 Awards.** “Security and Compliance in the Digital Transformation” category of the “Digital Era 2016” awards organised by Computing magazine. The award recognises the company’s initiatives to protect its information and communication systems.
- **2017 Cionet and eNET Digital Leadership Award** in the large enterprise category. The award acknowledged that: “By 2020, Iberdrola will have invested 8 billion euros in digitisation, 3.1 billion of which correspond to the period 2016-2020”.
- **EnerTIC Awards.** Iberdrola Distribución’s project “Inventory and Network Maintenance Management Using NFC Tags” won the Smart Grid category at the 5th EnerTIC Awards.
- **Startup Olé,** entrepreneurship and innovation. Award for supporting entrepreneurship and innovation granted at the Startup Olé event, organised by the University of Salamanca.
- **The "Big Bang" National Innovation Prize** to Scottish Power awarded by the Utility Week Stars Award.
- **Scottish Power Transmission** achieved “leadership” in regulator OFGEM’s Environmental Discretionary Reward Scheme.
- **Best Innovation Award.** Scottish Power Energy Networks won the Best Innovation Award for their "Dynamic Cable Rating system" at the Scottish Green Energy Awards.
- **‘100 Best Ideas of the Year’ Award.** Awarded by Actualidad Económica magazine to the Smart Solar Project.
- Elektro received the Strategy 2017 Innovation Value Brazil Award.
- Elektro receives the first prize in the category of Innovation in Customer Relationship in the Smart Contact Center.
- AVANGRID was ranked among the top 100 global energy leaders by Thomson Reuters.
- Awarded **“Best renewable initiative”** by the Qatari electricity company Kahramaa.
- Iberdrola Distribución’s **Layca Project** won the Quality Innovation Award in Spain’s Basque Country.





$E=mc^2$ $\lim_{x \rightarrow 0} \frac{\sin x}{x} = 1$ $\frac{d}{dx} p(x)y = \frac{dy}{dx}$ $F(xy)' = 0$ $\frac{d}{dx} (e^x) = e^x$ $\frac{d}{dx} (e^{x^2}) = 2xe^{x^2}$ $\frac{d}{dx} (e^{\sqrt{1+y}}) = \frac{1}{2\sqrt{1+y}}$ $\frac{d}{dx} (e^{\sqrt{1+y^2}}) = \frac{y}{\sqrt{1+y^2}}$ $\frac{d}{dx} (e^{\sqrt{1+y^3}}) = \frac{3y^2}{2\sqrt{1+y^3}}$ $\frac{d}{dx} (e^{\sqrt{1+y^4}}) = \frac{2y^3}{\sqrt{1+y^4}}$ $\frac{d}{dx} (e^{\sqrt{1+y^5}}) = \frac{5y^4}{2\sqrt{1+y^5}}$ $\frac{d}{dx} (e^{\sqrt{1+y^6}}) = \frac{3y^5}{\sqrt{1+y^6}}$ $\frac{d}{dx} (e^{\sqrt{1+y^7}}) = \frac{7y^6}{2\sqrt{1+y^7}}$ $\frac{d}{dx} (e^{\sqrt{1+y^8}}) = \frac{4y^7}{\sqrt{1+y^8}}$ $\frac{d}{dx} (e^{\sqrt{1+y^9}}) = \frac{9y^8}{2\sqrt{1+y^9}}$ $\frac{d}{dx} (e^{\sqrt{1+y^{10}}}) = \frac{5y^9}{\sqrt{1+y^{10}}}$ $\frac{d}{dx} (e^{\sqrt{1+y^{11}}}) = \frac{11y^{10}}{2\sqrt{1+y^{11}}}$ $\frac{d}{dx} (e^{\sqrt{1+y^{12}}}) = \frac{6y^{11}}{\sqrt{1+y^{12}}}$ $\frac{d}{dx} (e^{\sqrt{1+y^{13}}}) = \frac{13y^{12}}{2\sqrt{1+y^{13}}}$ $\frac{d}{dx} (e^{\sqrt{1+y^{14}}}) = \frac{7y^{13}}{\sqrt{1+y^{14}}}$ $\frac{d}{dx} (e^{\sqrt{1+y^{15}}}) = \frac{15y^{14}}{2\sqrt{1+y^{15}}}$ $\frac{d}{dx} (e^{\sqrt{1+y^{16}}}) = \frac{8y^{15}}{\sqrt{1+y^{16}}}$ $\frac{d}{dx} (e^{\sqrt{1+y^{17}}}) = \frac{17y^{16}}{2\sqrt{1+y^{17}}}$ $\frac{d}{dx} (e^{\sqrt{1+y^{18}}}) = \frac{9y^{17}}{\sqrt{1+y^{18}}}$ $\frac{d}{dx} (e^{\sqrt{1+y^{19}}}) = \frac{19y^{18}}{2\sqrt{1+y^{19}}}$ $\frac{d}{dx} (e^{\sqrt{1+y^{20}}}) = \frac{10y^{19}}{\sqrt{1+y^{20}}}$ $\frac{d}{dx} (e^{\sqrt{1+y^{21}}}) = \frac{21y^{20}}{2\sqrt{1+y^{21}}}$ $\frac{d}{dx} (e^{\sqrt{1+y^{22}}}) = \frac{11y^{21}}{\sqrt{1+y^{22}}}$ $\frac{d}{dx} (e^{\sqrt{1+y^{23}}}) = \frac{23y^{22}}{2\sqrt{1+y^{23}}}$ $\frac{d}{dx} (e^{\sqrt{1+y^{24}}}) = \frac{12y^{23}}{\sqrt{1+y^{24}}}$ $\frac{d}{dx} (e^{\sqrt{1+y^{25}}}) = \frac{25y^{24}}{2\sqrt{1+y^{25}}}$ $\frac{d}{dx} (e^{\sqrt{1+y^{26}}}) = \frac{13y^{25}}{\sqrt{1+y^{26}}}$ $\frac{d}{dx} (e^{\sqrt{1+y^{27}}}) = \frac{27y^{26}}{2\sqrt{1+y^{27}}}$ $\frac{d}{dx} (e^{\sqrt{1+y^{28}}}) = \frac{14y^{27}}{\sqrt{1+y^{28}}}$ $\frac{d}{dx} (e^{\sqrt{1+y^{29}}}) = \frac{29y^{28}}{2\sqrt{1+y^{29}}}$ $\frac{d}{dx} (e^{\sqrt{1+y^{30}}}) = \frac{15y^{29}}{\sqrt{1+y^{30}}}$ $\frac{d}{dx} (e^{\sqrt{1+y^{31}}}) = \frac{31y^{30}}{2\sqrt{1+y^{31}}}$ $\frac{d}{dx} (e^{\sqrt{1+y^{32}}}) = \frac{16y^{31}}{\sqrt{1+y^{32}}}$ $\frac{d}{dx} (e^{\sqrt{1+y^{33}}}) = \frac{33y^{32}}{2\sqrt{1+y^{33}}}$ $\frac{d}{dx} (e^{\sqrt{1+y^{34}}}) = \frac{17y^{33}}{\sqrt{1+y^{34}}}$ $\frac{d}{dx} (e^{\sqrt{1+y^{35}}}) = \frac{35y^{34}}{2\sqrt{1+y^{35}}}$ $\frac{d}{dx} (e^{\sqrt{1+y^{36}}}) = \frac{18y^{35}}{\sqrt{1+y^{36}}}$ $\frac{d}{dx} (e^{\sqrt{1+y^{37}}}) = \frac{37y^{36}}{2\sqrt{1+y^{37}}}$ $\frac{d}{dx} (e^{\sqrt{1+y^{38}}}) = \frac{19y^{37}}{\sqrt{1+y^{38}}}$ $\frac{d}{dx} (e^{\sqrt{1+y^{39}}}) = \frac{39y^{38}}{2\sqrt{1+y^{39}}}$ $\frac{d}{dx} (e^{\sqrt{1+y^{40}}}) = \frac{20y^{39}}{\sqrt{1+y^{40}}}$ $\frac{d}{dx} (e^{\sqrt{1+y^{41}}}) = \frac{41y^{40}}{2\sqrt{1+y^{41}}}$ $\frac{d}{dx} (e^{\sqrt{1+y^{42}}}) = \frac{21y^{41}}{\sqrt{1+y^{42}}}$ $\frac{d}{dx} (e^{\sqrt{1+y^{43}}}) = \frac{43y^{42}}{2\sqrt{1+y^{43}}}$ $\frac{d}{dx} (e^{\sqrt{1+y^{44}}}) = \frac{22y^{43}}{\sqrt{1+y^{44}}}$ $\frac{d}{dx} (e^{\sqrt{1+y^{45}}}) = \frac{45y^{44}}{2\sqrt{1+y^{45}}}$ $\frac{d}{dx} (e^{\sqrt{1+y^{46}}}) = \frac{23y^{45}}{\sqrt{1+y^{46}}}$ $\frac{d}{dx} (e^{\sqrt{1+y^{47}}}) = \frac{47y^{46}}{2\sqrt{1+y^{47}}}$ $\frac{d}{dx} (e^{\sqrt{1+y^{48}}}) = \frac{24y^{47}}{\sqrt{1+y^{48}}}$ $\frac{d}{dx} (e^{\sqrt{1+y^{49}}}) = \frac{49y^{48}}{2\sqrt{1+y^{49}}}$ $\frac{d}{dx} (e^{\sqrt{1+y^{50}}}) = \frac{25y^{49}}{\sqrt{1+y^{50}}}$ $\frac{d}{dx} (e^{\sqrt{1+y^{51}}}) = \frac{51y^{50}}{2\sqrt{1+y^{51}}}$ $\frac{d}{dx} (e^{\sqrt{1+y^{52}}}) = \frac{26y^{51}}{\sqrt{1+y^{52}}}$ $\frac{d}{dx} (e^{\sqrt{1+y^{53}}}) = \frac{53y^{52}}{2\sqrt{1+y^{53}}}$ $\frac{d}{dx} (e^{\sqrt{1+y^{54}}}) = \frac{27y^{53}}{\sqrt{1+y^{54}}}$ $\frac{d}{dx} (e^{\sqrt{1+y^{55}}}) = \frac{55y^{54}}{2\sqrt{1+y^{55}}}$ $\frac{d}{dx} (e^{\sqrt{1+y^{56}}}) = \frac{28y^{55}}{\sqrt{1+y^{56}}}$ $\frac{d}{dx} (e^{\sqrt{1+y^{57}}}) = \frac{57y^{56}}{2\sqrt{1+y^{57}}}$ $\frac{d}{dx} (e^{\sqrt{1+y^{58}}}) = \frac{29y^{57}}{\sqrt{1+y^{58}}}$ $\frac{d}{dx} (e^{\sqrt{1+y^{59}}}) = \frac{59y^{58}}{2\sqrt{1+y^{59}}}$ $\frac{d}{dx} (e^{\sqrt{1+y^{60}}}) = \frac{30y^{59}}{\sqrt{1+y^{60}}}$ $\frac{d}{dx} (e^{\sqrt{1+y^{61}}}) = \frac{61y^{60}}{2\sqrt{1+y^{61}}}$ $\frac{d}{dx} (e^{\sqrt{1+y^{62}}}) = \frac{31y^{61}}{\sqrt{1+y^{62}}}$ $\frac{d}{dx} (e^{\sqrt{1+y^{63}}}) = \frac{63y^{62}}{2\sqrt{1+y^{63}}}$ $\frac{d}{dx} (e^{\sqrt{1+y^{64}}}) = \frac{32y^{63}}{\sqrt{1+y^{64}}}$ $\frac{d}{dx} (e^{\sqrt{1+y^{65}}}) = \frac{65y^{64}}{2\sqrt{1+y^{65}}}$ $\frac{d}{dx} (e^{\sqrt{1+y^{66}}}) = \frac{33y^{65}}{\sqrt{1+y^{66}}}$ $\frac{d}{dx} (e^{\sqrt{1+y^{67}}}) = \frac{67y^{66}}{2\sqrt{1+y^{67}}}$ $\frac{d}{dx} (e^{\sqrt{1+y^{68}}}) = \frac{34y^{67}}{\sqrt{1+y^{68}}}$ $\frac{d}{dx} (e^{\sqrt{1+y^{69}}}) = \frac{69y^{68}}{2\sqrt{1+y^{69}}}$ $\frac{d}{dx} (e^{\sqrt{1+y^{70}}}) = \frac{35y^{69}}{\sqrt{1+y^{70}}}$ $\frac{d}{dx} (e^{\sqrt{1+y^{71}}}) = \frac{71y^{70}}{2\sqrt{1+y^{71}}}$ $\frac{d}{dx} (e^{\sqrt{1+y^{72}}}) = \frac{36y^{71}}{\sqrt{1+y^{72}}}$ $\frac{d}{dx} (e^{\sqrt{1+y^{73}}}) = \frac{73y^{72}}{2\sqrt{1+y^{73}}}$ $\frac{d}{dx} (e^{\sqrt{1+y^{74}}}) = \frac{37y^{73}}{\sqrt{1+y^{74}}}$ $\frac{d}{dx} (e^{\sqrt{1+y^{75}}}) = \frac{75y^{74}}{2\sqrt{1+y^{75}}}$ $\frac{d}{dx} (e^{\sqrt{1+y^{76}}}) = \frac{38y^{75}}{\sqrt{1+y^{76}}}$ $\frac{d}{dx} (e^{\sqrt{1+y^{77}}}) = \frac{77y^{76}}{2\sqrt{1+y^{77}}}$ $\frac{d}{dx} (e^{\sqrt{1+y^{78}}}) = \frac{39y^{77}}{\sqrt{1+y^{78}}}$ $\frac{d}{dx} (e^{\sqrt{1+y^{79}}}) = \frac{79y^{78}}{2\sqrt{1+y^{79}}}$ $\frac{d}{dx} (e^{\sqrt{1+y^{80}}}) = \frac{40y^{79}}{\sqrt{1+y^{80}}}$ $\frac{d}{dx} (e^{\sqrt{1+y^{81}}}) = \frac{81y^{80}}{2\sqrt{1+y^{81}}}$ $\frac{d}{dx} (e^{\sqrt{1+y^{82}}}) = \frac{41y^{81}}{\sqrt{1+y^{82}}}$ $\frac{d}{dx} (e^{\sqrt{1+y^{83}}}) = \frac{83y^{82}}{2\sqrt{1+y^{83}}}$ $\frac{d}{dx} (e^{\sqrt{1+y^{84}}}) = \frac{42y^{83}}{\sqrt{1+y^{84}}}$ $\frac{d}{dx} (e^{\sqrt{1+y^{85}}}) = \frac{85y^{84}}{2\sqrt{1+y^{85}}}$ $\frac{d}{dx} (e^{\sqrt{1+y^{86}}}) = \frac{43y^{85}}{\sqrt{1+y^{86}}}$ $\frac{d}{dx} (e^{\sqrt{1+y^{87}}}) = \frac{87y^{86}}{2\sqrt{1+y^{87}}}$ $\frac{d}{dx} (e^{\sqrt{1+y^{88}}}) = \frac{44y^{87}}{\sqrt{1+y^{88}}}$ $\frac{d}{dx} (e^{\sqrt{1+y^{89}}}) = \frac{89y^{88}}{2\sqrt{1+y^{89}}}$ $\frac{d}{dx} (e^{\sqrt{1+y^{90}}}) = \frac{45y^{89}}{\sqrt{1+y^{90}}}$ $\frac{d}{dx} (e^{\sqrt{1+y^{91}}}) = \frac{91y^{90}}{2\sqrt{1+y^{91}}}$ $\frac{d}{dx} (e^{\sqrt{1+y^{92}}}) = \frac{46y^{91}}{\sqrt{1+y^{92}}}$ $\frac{d}{dx} (e^{\sqrt{1+y^{93}}}) = \frac{93y^{92}}{2\sqrt{1+y^{93}}}$ $\frac{d}{dx} (e^{\sqrt{1+y^{94}}}) = \frac{47y^{93}}{\sqrt{1+y^{94}}}$ $\frac{d}{dx} (e^{\sqrt{1+y^{95}}}) = \frac{95y^{94}}{2\sqrt{1+y^{95}}}$ $\frac{d}{dx} (e^{\sqrt{1+y^{96}}}) = \frac{48y^{95}}{\sqrt{1+y^{96}}}$ $\frac{d}{dx} (e^{\sqrt{1+y^{97}}}) = \frac{97y^{96}}{2\sqrt{1+y^{97}}}$ $\frac{d}{dx} (e^{\sqrt{1+y^{98}}}) = \frac{49y^{97}}{\sqrt{1+y^{98}}}$ $\frac{d}{dx} (e^{\sqrt{1+y^{99}}}) = \frac{99y^{98}}{2\sqrt{1+y^{99}}}$ $\frac{d}{dx} (e^{\sqrt{1+y^{100}}}) = \frac{50y^{99}}{\sqrt{1+y^{100}}}$

3

Innovation strategy

Vision

Iberdrola has made sweeping changes in the past 15 years, clearly one step ahead of the energy transition to face the challenges of climate change and the need for clean electricity.

With an history of over 170 years, **Iberdrola is today a multinational energy leader** that produces and supplies electricity to around 100 million people in the countries in which it operates. We are also a leader in clean energies, as well as being the biggest producer of renewable energies among European utilities, a world leader in onshore installed wind power, and the cleanest electricity company in the USA, with almost zero emissions.

Throughout this transformation process, **innovation has proved to be a strategic variable** present in all of the group's activities and businesses. In the future, we want to continue being innovation leaders within the energy sector. Our activities in this field in-

clude sustainable development, promoting renewable energies, automation, leveraging the opportunities offered by digitalisation, and the commitment to technologies and new business models which enable the electrification and decarbonisation of the economy.

To this end, **Iberdrola is committed to creating an innovative ecosystem** based on attracting

outside talent and exploring new ways of collaboration, with the aim of designing new solutions that create sustainable value for society and our stakeholders. The company also promotes internal talent and implements a **culture of innovation** at all levels, enabling us to successfully incorporate new technologies.

On this basis, Iberdrola is undergoing a period of growth in order to consolidate

its position as the *utility of the future* at the service of society and people, investing our energy in building a sustainable future.

“At Iberdrola we are leading the change. Technology, innovation and people are the cornerstones of our transformation.”

Iberdrola Innovation Plan 2015-2017

The deployment of innovative strategy both in management and technology has converted Iberdrola into the world leader and benchmark in R&D&I, as a result of the successful implementation of a common model for all its geographic and business areas, collaboration with technology providers and the promotion of a culture of innovation.

The Iberdrola 2015-2017 R&D&I Plan consolidates the research, development and innovation plans of the different Business Units during this period. In line with the Group's outlook, the Plan reinforces the commitment to sustainable development, promotion of renewable energies, emerging technologies and digitisation.

Two basic pillars have been established to become world leaders in R&D&I in the energy sector:

- › **R&D&I Management Benchmarks** with a unique and global management model for all the countries in which the Company operates with a view to providing a common framework for promoting innovation and making the most of the results. The following goals have been set:

 - Upholding our leadership in innovation management.
 - Consolidation of the international organisation and management model (open and decentralised).
 - Innovation Leaders: presence in all rankings.
- › **The technology positioning of the Iberdrola Group** by creating value at an international level with R&D&I initiatives and projects in key technology areas. The following goals are sought:

 - Creation of value in businesses by undertaking R&D&I projects in key technology areas.
 - Consolidation of the PERSEO International Startup program Consolidation- Corporate Venture Capital Programme
 - Fostering innovation through the Supplier Innovation Programme.
 - Consolidating the presence of the Iberdrola Group in Qatar and inauguration of the Iberdrola Innovation Middle East Technology Centre.
 - Attracting external talent, strengthening links with universities, and promoting internal talent.

The company focuses its efforts on developing initiatives in smart grids, clean generation, offshore wind power, digitisation and new business technologies and models.

Thanks to its commitment to innovation, Iberdrola has been recognized as the most innovative *utility* in Spain and the third in Europe, according to the European Commission's ranking. The Group spent 246 million euros on R&D&I activities in 2017 and 267 million euros in 2018.

Effort in R&D&I
(EUR million)

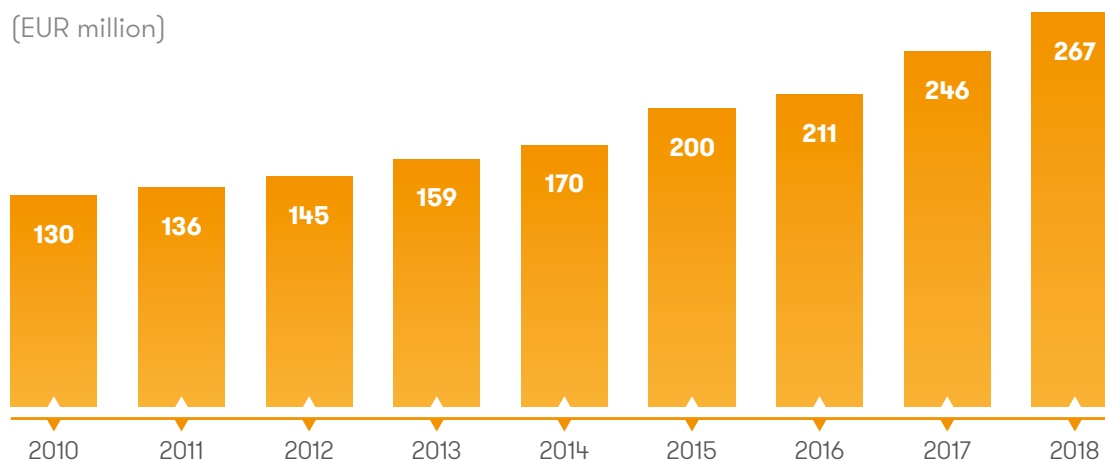

More than 200 projects are currently under development to promote sustainability, the promotion of renewable energies and emerging technologies. Iberdrola's portfolio of Research, Development and Innovation (R&D&I) projects comprises activities in four main areas, reflecting the company's strong commitment to sustainable development and the promotion of emerging technologies:

- Non-renewable sustainable generation.
 - Clean generation.
 - Energy efficiency.
- Networks for the future.
- Renewable energy sources.
- Cross-sector technologies: ICT, environment, electric mobility, digitisation, energy storage.

Sustainable generation

The efforts in the Generation area focused on increasing the flexibility and operating efficiency of facilities, respect for the environment and improving facility safety.



Networks of the future

The Group's R&D&I activities in electric power distribution are focused on optimising the distribution network (smart grids and digitisation), particularly in the areas of occupational safety, environmental factors and the improvement in the quality of the supply.

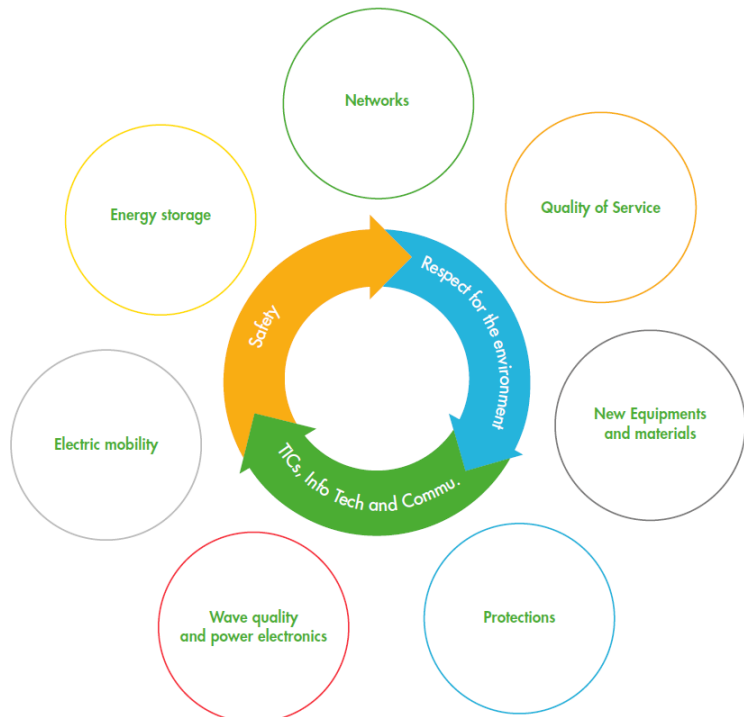

Renewable Energies

Innovation activities in the Renewable Energies area focused on improving the efficiency of operating assets and the integration of renewable energies including storage system analysis and optimising designs or processes for ongoing and future projects associated with offshore wind power.



Cross-sector technologies

Including activities related to information and communications technologies (ICT), engineering and other cross-cutting areas such as electric vehicles, energy storage, environmental activities, digital transformation initiatives, etc.

It should be noted that all our R&D&I initiatives at Iberdrola have been and will be in line with its commitment to sustainability and care for the environment, and thus taking into account the protection of biodiversity and the reduction of environmental impacts.

From a technical point of view, strategic R&D&I areas have been addressed with international initiatives and projects, essentially in Spain, the United Kingdom, the US, Brazil and Mexico. The chart shows the expected percentages allocated to each technology area:

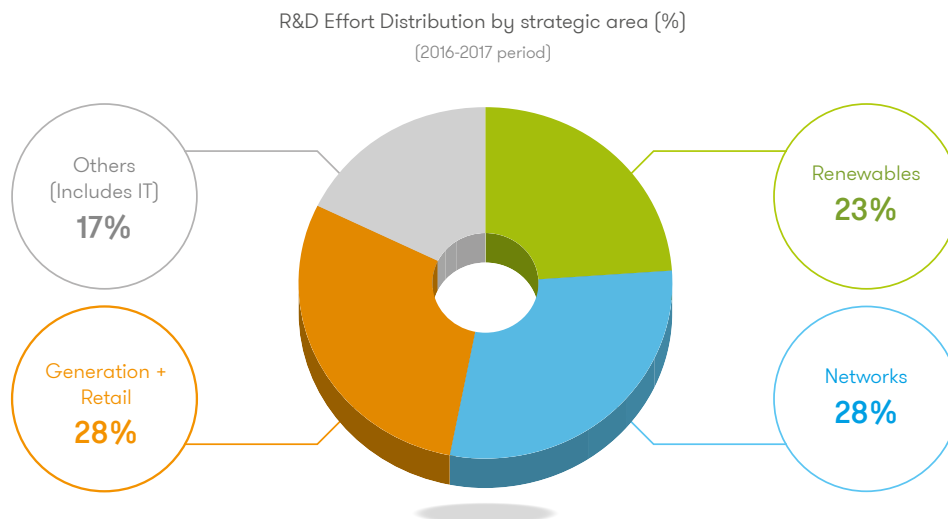

Iberdrola Innovation Plan 2018-2022:

“setting solid foundations for sustainable growth in the next decade”

The new **Innovation Plan 2018-2022** reasserts the focus of the previous plan, maintaining its two strategic pillars and integrating Neoennergia into its international R&D&I management model. The plan is also aligned with the Group’s outlook for this period, in line with the three fundamental drivers of the transformation process that the energy sector is currently undergoing: **decarbonisation**, which leads to strong process of electrification of the economy; **technological advances**, which are making it possible to reduce costs and create new business opportunities; and **greater consumer connectivity**, which gives them more importance and capacity for interaction.

These three trends create big opportunities for Iberdrola’s three areas of business: **more renewables**, **more and smarter grids and more consumer solutions**. It will also be essential to continue developing the **digital transformation**, providing intelligence to the system.

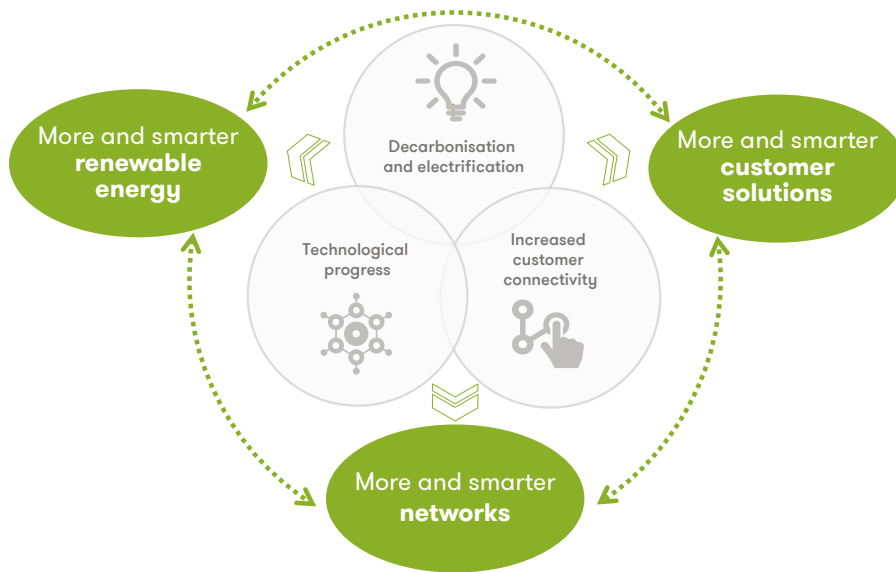

The company's innovation activities will be concentrated into these three businesses. However, Iberdrola's portfolio of Research, Development and Innovation projects (R&D&I) will include activities in all its strategic and geographical areas in Spain, the UK, the USA, Mexico and Brazil:

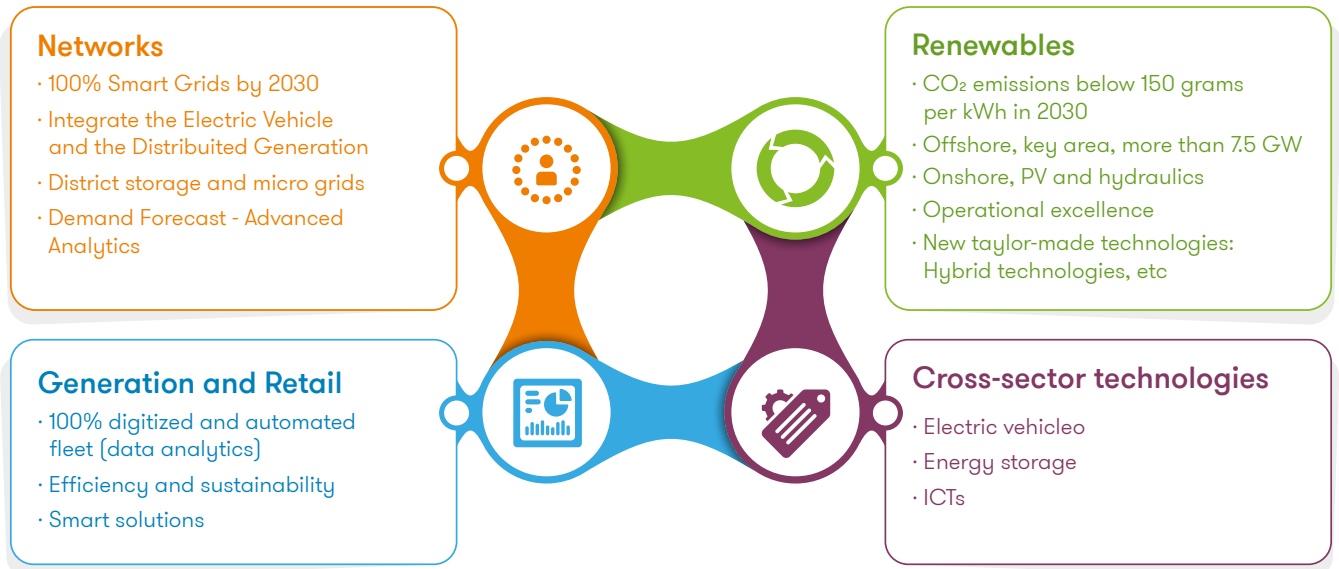

All of this will reinforce our impact on the **United Nations Sustainable Development Goals**. As an energy company committed to sustainability, our activities contribute to achieving Goals 7 (Affordable and clean energy) and 13 (Climate action). Furthermore, our social commitment allows us to contribute directly or indirectly to the rest of the SDGs.

SUSTAINABLE DEVELOPMENT GOALS





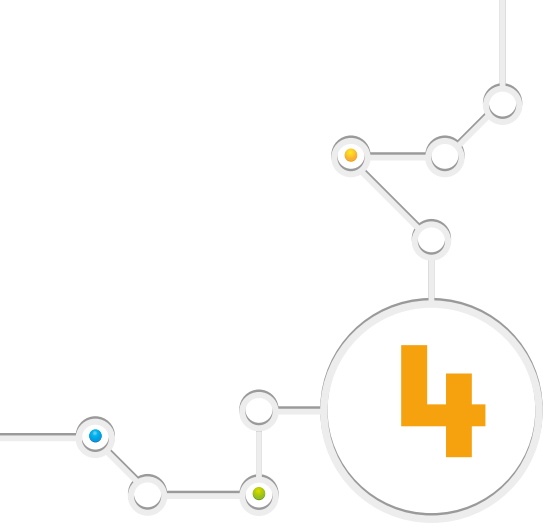

R&D&I management benchmarks

One Global, Homogeneous and Systematic
Innovation Model for the whole organisation

Iberdrola's R&D&I Management System allows innovation to be valued as a basic activity of an organisation that is managed in a consistent and efficient way, articulated according to a group of well-defined and documented processes, with people responsible for the different activities and assigning resources appropriately.

R&D&I Management System

Iberdrola is aware that innovation requires planning to ensure that all the R&D&I activities of all the businesses in the Group are coordinated and structured. For this reason, an R&D&I Management System was implemented in mid-2007 in accordance with standard UNE 166002:2014 and certified by AENOR, thus providing systematised and standardised criteria for R&D&I activities that can be implemented globally and efficiently.

Iberdrola has structured its R&D&I Management System so that the Innovation Division can provide Business Units with a global model, since we believe that there should be a single, standard and systematic innovation process for the entire organisation. The development of a specific structure for this management, such as R&D&I committees, has been fundamental for managing the innovative process from a perspective that is closer to them.

The chart below shows the international process map for R&D&I management across the Iberdrola Group.

R&D Management

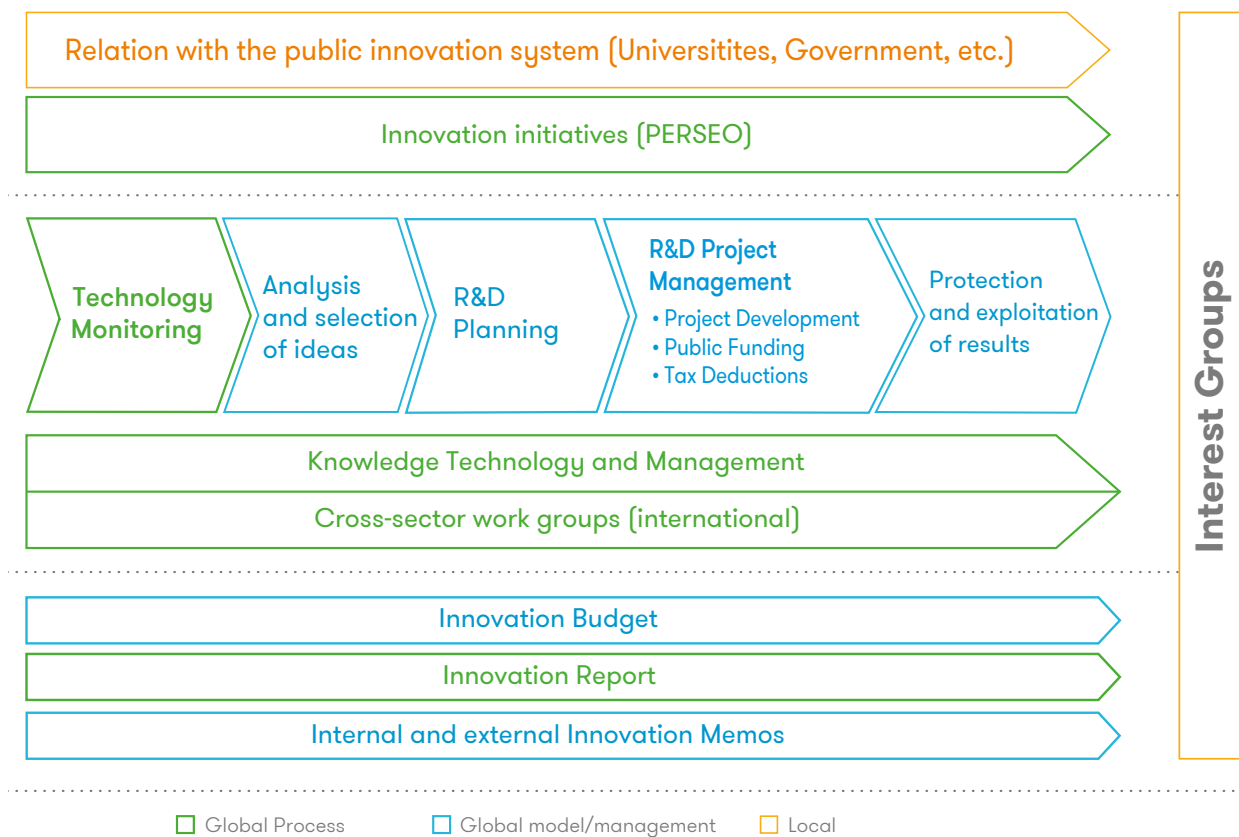

Iberdrola understands innovation as a decentralised and open process:

- **decentralised** because the process is carried out independently in each business unit with support and coordination from the Innovation Department.
- **open** because Iberdrola considers itself a technology driving company. As such, its aim is to involve the Group's technology suppliers, such as universities, technological centres and equipment manufacturers in the innovation process.

The chart below shows the different internal and external agents that form part of innovation at Iberdrola on a day-to-day basis:

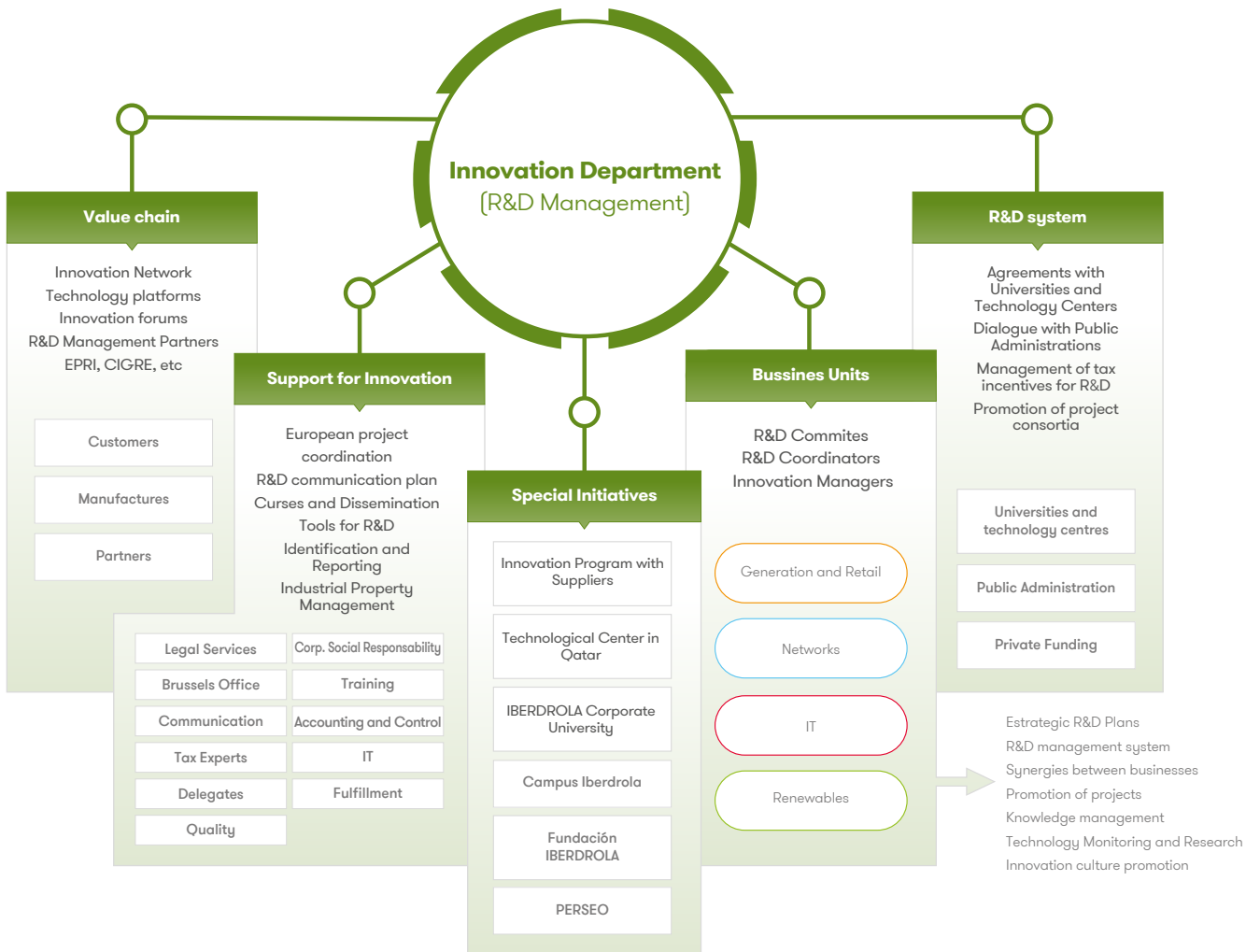

The interaction of the Innovation Department with the different businesses of the company is described below:

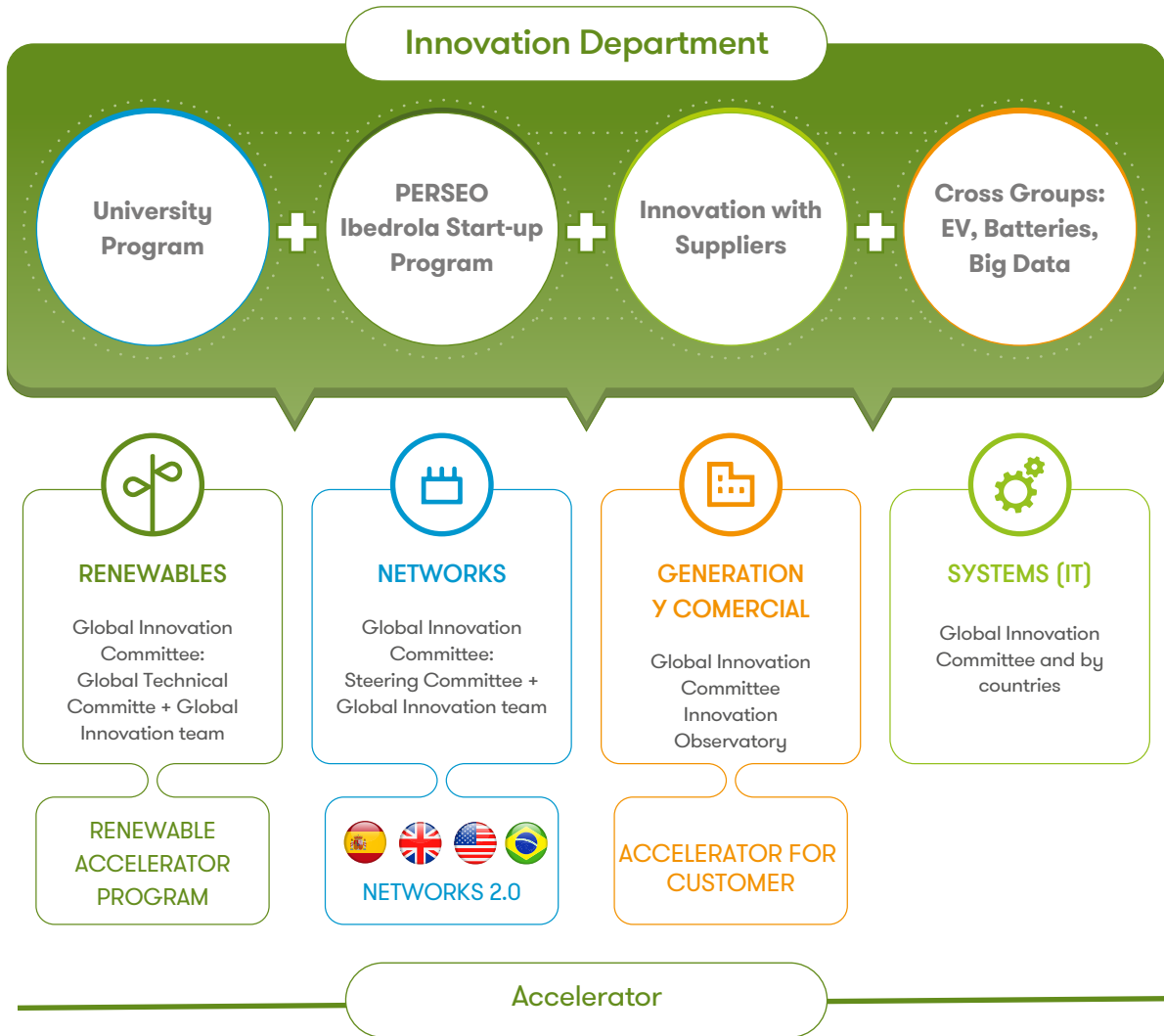

Within the Iberdrola Group, the Innovation Department, in collaboration with Legal Services, is responsible for establishing the guidelines and requirements to be followed for the application of industrial invention protections, as well as serving as a guide and establishing the appropriate foundations and mechanisms to protect and manage both the Company's and the Group's industrial inventions. To do this, the company has a **Manual of Good Practices for Protecting Iberdrola Group Industrial Inventions** which applies to all Iberdrola personnel who carry out innovative projects or activities and who, therefore, may require a protection mechanism.





5

Culture of innovation and talent

A culture that encourages innovation is capable of attracting the best talent and generating creative solutions to transform the current energy model.

Iberdrola's open innovation model aims to combine internal knowledge with external talent, allowing the company to grow and differentiate itself, developing solutions in the areas of sustainable development, the promotion of renewable energies, emerging technologies and digitisation.

Attracting external talent

IBERDROLA Universities Programme Iberdrola U

As a result of its support to the academic world, Iberdrola has launched the **IBERDROLA Universities Programme Iberdrola U**.

This programme is focused on strengthening the relationship between the company and the academic world with a series of resources and activities, aimed at attracting talent, transferring knowledge and contributing to our society. Students, scholarship recipients, entrepreneurs, professors, researchers and Iberdrola's employees are part of a network that fosters training, entrepreneurship and research.

Iberdrola has signed a series of collaboration agreements with the main universities where Iberdrola is present: MIT - Massachusetts Institute of Technology in the US, the Monterrey Institute of Technology in Mexico, the University of Strathclyde in the UK, and the Comillas Pontifical University and the University of Salamanca in Spain. The Universities Programme currently has a scope of **around 200,000 students, 20,000 professors and 1,500 scholarship recipients**.



The programme is based on **five lines of action**: Charis, development of R&D projects, training through scholarship for students, internal training of Iberdrola employees and support for young entrepreneurs.

<https://www.iberdrola.com/personas-talento/programa-universidades>

University Chairs

Massachusetts Institute of Technology

Iberdrola-Avangrid Chair with MIT

Created between Iberdrola-AVANGRID and the MIT in 2017, the purpose of this Chair is to promote research and training on electrical systems, as part of the MIT Energy Initiative (MITeI) framework, whose mission is to create efficient solutions to meet global needs with the least environmental impact and while mitigating climate change.

Iberdrola and its US subsidiary AVANGRID will therefore work together with this prestigious university for five years with the aim of promoting innovation in the field of clean energies.



Rafael Reif (president of MIT) and Ignacio Galán (chairman of Iberdrola)

Historically, Iberdrola has collaborated with the prestigious MIT in research-related initiatives. In this context, it is worth mentioning a study on the key elements of the electricity company of the future, developed in collaboration with the Comillas Pontifical University.

Under the tagline the *Utility of the Future*, this study presents a picture of an evolving energy sector where decarbonisation, measures to mitigate climate change, new technologies, digitisation, renewable energies, and power storage will continue setting the pace of change not only in sector regulations but also in a more flexible and efficient consumption of power. In this study, MIT researchers had collaborated with Iberdrola, which in addition to being a sponsor was part of the Advisory Committee, with the participation of the company's Networks business and the Global Regulation department.



Iberdrola Chair in Energy and Innovation at the Comillas Pontifical University

The Iberdrola Chair in Energy and Innovation at the University of Comillas-ICAI was created in October 2012 with the following goals:

- To be an instrument for formalising a stable partnership agreement between the University and Iberdrola to carry out research, innovation and training activities in fields of knowledge with strategic interest to Iberdrola.
- The creation of a University-Iberdrola link to render a strategic nature to this alliance within the field of innovative knowledge creation and transfer that goes beyond the strictly economic area.
- To be a University tool for boosting research, development, innovation and teaching, as well as working in favour of social and cultural causes.



8th Centenary Chair with the University of Salamanca

This chair was created in 2008 as an action framework that formalises the collaboration between both organisations and promotes education, research and innovation in fields of knowledge of special interest to both parties. The main purpose is to foster university-business technology transfer and become a framework for collaboration in the launch of R&D&I projects and training initiatives in common areas of interest. The Chair also seeks to promote specialised training in fields of knowledge which are of greatest interest to Iberdrola, and to carry out other social and cultural activities.

This is the first of the Eighth Centenary Chairs in the University Excellence Programme (USAL) approved by the Interinstitutional Commission to commemorate the eight centuries of the USAL in 2018. The aim is to create research, teaching, and knowledge transfer units, designed to incorporate prestigious researchers into the academic institution through a public-private partnership system. The Chair focuses on the analysis and feasibility of technologies and business models for a decarbonised and electrified energy sector. It will take place over an extendable period of two years.

In this way, the University of Salamanca fulfils its purpose of acting as a test bed for new formulas to better attract talent and maintain the level of excellence required for the future.



Ricardo Rivero (rector of the University of Salamanca) and Ignacio Galán (chairman of Iberdrola)



ScottishPower Chair in Smart Grids with the University of Strathclyde

The ScottishPower Chair in Smart Grids was set up by ScottishPower and the University of Strathclyde in 2007 to conduct research and address some of the challenges for the energy sector. It serves as a basis for strengthening the international impact and international consortiums in this area of engineering.

Iberdrola has also entered into a series of agreements with this university to take on some of the challenges for the energy sector and to conduct R&D projects:

- Technology Innovation Centre (TIC): Renowned as amongst the UK's leading international technology universities, the University of Strathclyde has developed the Technology Innovation Centre, which is transforming the way in which academics, businesses, industry and the public sector work together to provide Scotland with a global competitive edge. The TIC offers an extensive breadth of research and innovation areas, in which energy is one of the main activity areas.
- The Renewable Energies business at ScottishPower has been working alongside the TIC since its inception. We are benefiting from the TIC's collaborative approach in offering multiple projects and thus improve our renewable assets. The main activity areas during recent years centre around:
 - › Asset management
 - › Data Analysis
 - › Lifecycle
 - › Technical skills

- **Power Networks Demonstration Centre (PNDC):** The Power Networks Demonstration Centre was jointly created by the University of Strathclyde, *Scottish Enterprise*, the Scottish Finance Council, *Scottish Power* and *Scottish and Southern Energy*, with the purpose of accelerating the integration of new smart technologies into the electricity sector. The PNDC provides a low- and medium-voltage distribution system (up to 11 kV) that can be operated without a grid connection and therefore enables rapid and secure integration and validation of new technologies under real-life functional operating conditions. Its main research areas include asset management, communications, integration systems, grids, active supply and demand management, power electronics, distributed energy, protection, control, sensors and metering. ScottishPower is actively partnering the PNDC in undertaking several R&D projects in these areas.



Chair with the Monterrey Institute of Technology

Iberdrola and the Monterrey Institute of Technology have signed a chair that establishes their collaboration to strengthen the relationship between the company and the academic world in Mexico.

The aim of this agreement is to promote common interests and contribute to the innovation of strategic sectors through specialised training. It also aims to promote entrepreneurship through its own training actions and by identifying opportunities.

Both institutions share these lines of action: training, scholarships for undergraduate and postgraduate students, internal training for Iberdrola's employees, support for young entrepreneurs, development of R&D projects and support for chairs on specific topics.

R&D&I projects

Innovation is Iberdrola's main tool for guaranteeing the company's sustainability, efficiency and competitiveness. R&D&I efforts are focused on optimising operating conditions, improving safety and reducing environmental impact. The company's main R&D&I projects in partnership with universities are based on the following areas:

- **Smart grids:** we are focusing on optimising the distribution network, occupational safety, environmental aspects and supply quality
- **Environment and biodiversity:** we are committed to promoting innovation in this field and to reducing the environmental impacts of our activities.
- **Utility of the future:** thanks to our commitment to innovation, we have been recognised as the most innovative utility in Spain and the third in Europe.
- **Substations and high-voltage cables:** we are looking to make technical progress on high-voltage cable insulation and substation operation.
- **HVDC:** We have conducted different studies to optimise and develop the transmission of electrical energy through high-voltage direct current.
- **Nuclear technologies:** through our projects, models are developed that foresee and analyse possible accidents in nuclear power stations.
- **Energy markets:** We are improving energy markets by analysing them, predicting variables and optimising contractual models.
- **Robotics:** We innovate in new technologies applied to the operation and maintenance of energy infrastructures including robotics, sensorics, software, etc.
- **Wind resources:** we conduct activities aimed at improving the production and efficiency of wind-farms, studying costs and maintenance.

Scholarships

The main aim of the **Iberdrola International Master's Degree Scholarship programme** is to support the education of graduate professionals in fields that are crucial to the future success of our industry. It is an example of the company's commitment to fostering talent, excellence in training and research as pillars of employability and knowledge. Since this programme was launched in 2010, the number of scholarships has increased by over 300%, quadrupling the grants awarded, with more than 750 young people from multiple nationalities receiving scholarships.

In 2017, Iberdrola awarded more than 150 scholarships to attract the best candidates from across the world and continue strengthening relations between the company, national and international universities and technology centres. In this way, Iberdrola improves training for the up and coming generations, primarily in the area of energy, with a special focus on developing renewables, protecting biodiversity and boosting the efficiency of the energy.



This Scholarship program embodies Iberdrola's firm commitment to training and research as pillars of employability and the development of knowledge and thinking



The programme covers three areas:

- Firstly, it is intended to help the students complete their master’s and postgraduate studies in areas related to energy and the environment at top-level centres in Spain, the UK and the US.
- Secondly, it provides grants for research into energy and the environment, with which young researchers can carry out studies relating to energy and environmental sustainability at Spanish research centres or universities.
- The third area is related to the grants awarded by Fundación Iberdrola for training and research in the restoration workshops of the Prado Museum, and in the Bilbao Fine Arts Museum.

With its International Scholarship Programme and Research Grants Iberdrola contributes to the achievement of the UN Sustainable Development Goals (SDG) for 2030, which are included in the strategy of the company. The company focuses its efforts on meeting goals number 13 (climate action) and 7 (affordable and clean energy) and also contributing directly to decent work and economic growth (Goal 8), quality education (Goal 4) and gender equality (Goal 5).



Internal training

Iberdrola considers internal training and professional development to be key elements for the success of the organisation and the personal and professional satisfaction of its employees.

Thanks to the Iberdrola Universities Programme, our employees can receive training from prestigious universities and university students will be able to carry out scholarships and internships in the companies of the Iberdrola Group.

Also, through the agreement signed between Iberdrola and the universities of Comillas and Strathclyde, employees will be able to join the MBA specialising in the global energy industry. The aim of this MBA is to train professionals on topics including regulation, governance, energy and sustainability, leadership and strategy.

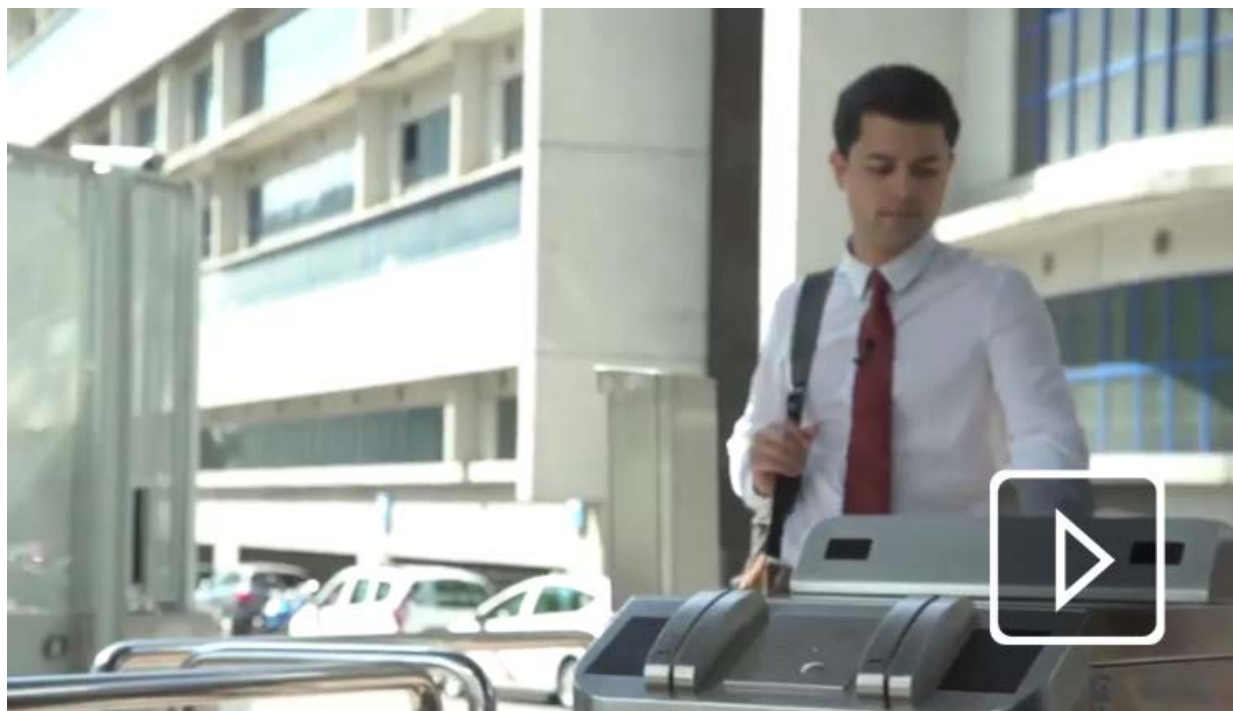

Young entrepreneurs

Iberdrola has joined entrepreneurship initiatives to fulfil our commitment to the employability of young people. In addition to agreements with leading universities, we have organised Entrepreneurship Programmes with 3 objectives: promoting and developing innovative ideas, attracting talent and fostering a culture of entrepreneurship.

To achieve these aims, Iberdrola provides both financial (financing, scholarship, competitions, hackathons, bootcamps and project grants) and training resources (specialised training, mentoring, advice and tutoring).

The main initiatives with young entrepreneurs at universities include:

**Massachusetts
Institute of
Technology**

Sandbox Innovation Fund Program: Iberdrola is the first utility to be involved in the Sandbox Innovation Fund Program. The programme is open to all MIT students and offers courses, workshops, events, advice/tutoring with entrepreneurs, industry experts and investors; and access to the resources necessary to achieve their objectives.



Scottish Power-Iberdrola Entrepreneurial Challenge: this initiative offers students at the University of Strathclyde the chance to face a major challenge so as to turn their ideas and projects into innovative start-ups:

- Getting the best out of the specialised training they will receive at the university.
- Leveraging the experience and connections of the industry experts with whom they will collaborate.
- Optimising the funding they will be given to launch their startup.

The initiative, aimed at the entire University of Strathclyde community, offers training and advice to help participants improve their skills and knowledge on matters related to the energy sector, by working in teams and shaping their projects through a pragmatic approach.

The challenge consists of the progressive identification, selection, and development of promising business ideas. These include new technologies, services, products, processes and business models. Complementary technologies and management innovations, including digital technologies and data analysis, will also be taken into consideration. All ideas must be used to achieve a common goal: to create or become part of commercially viable enterprises.



Energy Business Model Challenge: The Energy Business Model Challenge is a programme that aims to involve the students of the Monterrey Institute of Technology in the development of business models for the energy of the future.

The event allows students to make contact with businesses in the sector and get training and advice from specialist tutors on the subject.

In addition, it provides them with the necessary tools and resources to launch their startups.



Entrepreneurship at the University of Salamanca: Iberdrola is collaborating with the University of Salamanca on several workshops and mentoring programmes to encourage entrepreneurs to participate in initiatives such as Emprende Salamanca. These aim to promote the specialised training for students and arouse their interest in entrepreneurship in initiatives that address the challenges presented by the Utility of the Future.



And the **Energy Challenge Hackathon** which students take part in to develop their entrepreneurial skills.



Entrepreneurship at the Comillas Pontifical University: Iberdrola, in collaboration with the University of Comillas, offers university students several initiatives to encourage energy entrepreneurship: the Start-Camp hackathon, sponsorship of the ICAI Speed Club's electric vehicles, and Comillas Emprende, an initiative which enables top young entrepreneurs to develop their ideas and compete for an ultimate prize: turning their ideas into reality. These initiatives allows them to:

- Develop their business idea. Each team of students works on their idea over a weekend with the help of mentors from the sector.
- Immerse themselves in the startup ecosystem. Enjoy the talks and advice of successful entrepreneurs from the Spanish startup ecosystem.
- Expand their network of contacts. Get the opportunity to meet other people with the same ambitions.

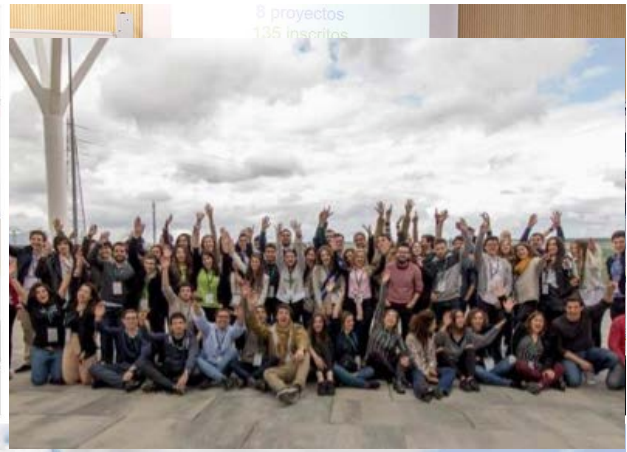

Through the **Young Entrepreneurs initiative**, Iberdrola held **9 hackathons or bootcamps** in 2017 and 2018 with the presence of **1,000 entrepreneurs** and the collaboration of 200 mentors. There have also been **more than 23 workshops** and **more than 3,200 mentoring hours**.

9 hackathons or bootcamps
with **1,000 entrepreneurs**
with the collaboration of over 200 mentors.
There have been more than 23 workshops
and more than 3,200 mentoring hours.

Iberdrola is committed to new generations as an engine for transformation and change to a better world. For this reason, the Universities Programme is a means to materialise the company's commitment to youth, innovation and, particularly, the promotion of research, entrepreneurship and collaboration with the world of science and universities.

Supporting internal talent

Iberdrola also considers that innovation cannot only be based on acquired technology. That is why we are committed to internal innovation as a source of value and as a key element in generating competitive advantages.

It is therefore essential that we promote internal innovation, research and development activities to lead the change toward the new energy model and make progress in fundamental work areas to ensure the development of a responsible business under the criteria of economic, social and environmental sustainability.

Accelerator Project

One important project in this regard is the *Accelerator* project, which kicked off in 2016 with the ambitious objective of identifying the key factors to turn the company into the largest global *utility* within the next ten years.

The initiative has been led by a multidisciplinary group of young employees who spent a year working across 4 areas: cultural change, smart living, customer experience and networks. The group, coming from Spain, the UK, the USA, Mexico and Brazil, has analysed the progress of selected successful *startups* launched by millennials like them and which have gone from a simple idea to a leading business in a short space of time.



Ignacio Galán with the members of the Accelerator Project

As well as frequent meetings, they research successful companies, analyse new possibilities, propose initiatives, etc. The whiteboards and walls are decorated with notes from leading technology companies that serve as inspiration in this laboratory where new proposals could take Iberdrola to the highest level.

As part of our commitment to digitisation, we maintain **an open approach**, collaborating with external agents that can bring value to the company, such as universities, public bodies, *freelancers*, expert programmers, designers, data scientists, companies from other sectors, suppliers, etc.

In 2017 and 2018, Iberdrola Renewables Business, Iberdrola Distribution and Iberdrola Generation launched the initiatives **Renewables Accelerator Programme**, **Networks 2.0** and **Accelerator for Customer**. Their aim is to satisfy the new demands of the market and of the business itself. These new initiatives have three shared objectives:

- Motivating and encouraging people
- Improving business performance
- Encouraging business innovation

Some of these new initiatives have already been successfully completed and new editions are set to take place within the next few years.

To sum up, so far, 7 initiatives have been launched in the past three years involving 245 employees, +45 business ideas and +48,000 hours dedicated to intrapreneurship.

The values that drive us

Iberdrola has internally launched the initiative “The Values That Drive Us”, based on the **12 values that inspire and embody the Company’s vocation and strategy**:

VALUE CALENDAR



The initiative is open to all the employees of the group that, through its online platform, aims to make known in greater detail the importance of each of the values within the company and the actions that support them.

In order to strengthen the initiative and contribute to its dissemination, several challenges have been set each month so that each employee feels identified with the company's identity, provide its skills and knowledge and contributes to its fulfilment.

Digital Summit

“Our employees are the protagonists of our digital transformation”

In 2017 and 2018, Iberdrola held two more editions of its **Digital Summits**, a two-day conference in which the following questions were answered: *What is the digital transformation?, What are the technologies that are leading it?, How are companies dealing with it? and What role do people play in this transformation?* We also got the opportunity to examine the impact of **the digital transformation on Iberdrola Group business around the world.**

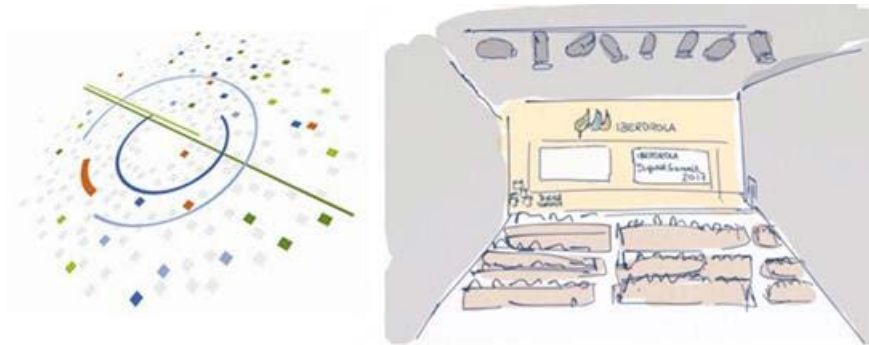

It was also a great opportunity to understand how this change is being tackled in other companies, with the participation of top speakers from leading companies such as **Amazon** and **Google**, among others.

The event was held in Madrid, at the Iberdrola Campus, becoming **IBERDROLA's** Digital event.

The events brought together more than 250 Iberdrola professionals from Spain, the UK, the USA, Brazil, Mexico and Portugal, almost doubling the number of attendees at the 2016 event.

We also saw participation from new business areas, many of them corporate areas conscious of the fact that digitisation is not just about technology or customer relationships or smart meters—it is something that affects us all.

The participants appreciated the talks by speakers from leading global companies such as **Google**, **Amazon**, **Gartner**, **Facebook**, **Telefónica**, **IBM** and **Microsoft**, who shared their vision, strategies and trends in the digital world.

We heard about digital and **disruptive technologies like Blockchain**, talked about the impact on people and culture in this new area, etc.



This time, the focus was on innovation, with the participation of several start-ups who told us about their experiences through an innovative format called PowerPitch.

The companies also had stands with fun activities like drone flights, augmented reality and internet of things, which allowed them to get closer to the attendees.

On the second day, the focus was on employees and internal talent. Through practical demonstrations of the digital projects, the business areas addressed several areas of technology (big data, analytics, web and mobility, internet of things, etc.), which aroused great interest.

All in all, the Digital Summit has become a unique event to understand the advances of the Group in the digital world. A place to share experiences, challenges, concerns and best practices as well as an extraordinary opportunity for networking.

Iberdrola Campus: A centre of innovation and excellence

The Iberdrola Campus is an exclusive and cutting-edge centre of progress intended to provide training and promote talent and excellence with the goal of designing the future energy model.



Located in San Agustín de Guadalix near Madrid, it is designed to serve as a multinational meeting point for the exchange of knowledge, experiences and good practices. It is a space for training, but also for networking, teamwork, and generating new ideas and strategies.

Innovation Room

In the Campus, you will find the Innovation Room, a stimulating environment designed to encourage creativity and help inspire ideas, promoting teamwork and interaction between employees. This room is where the Accelerator project was created and developed.



INNODAY 2018, our commitment to innovation and young talent

On 23 May, the international campus hosted **Innoday 2018**, a meeting place to learn about the innovative initiatives that are transforming the energy sector. These initiatives also aim to promote the transfer of knowledge and attract young talent.

Ignacio Galan, chairman of the company, opened the event, accompanied by representatives of some of the university centers with which we collaborate: the University of Salamanca, the Comillas Pontifical University, MIT - Massachusetts Institute of Technology, the University of Strathclyde and the Monterrey Institute of Technology.

During the event, the chairman underlined the group's commitment to universities and highlighted the role of innovation as the source of social and economic progress.

Innoday 2018 had two main focuses: the presentation of the Iberdrola Group Universities Programme and the innovation fair.



Commitment to Universities

At Innoday, the Iberdrola Group showed its support to universities as a basis for promoting entrepreneurship and presented the **Iberdrola Universities Programme Iberdrola U**.

The Iberdrola U program is focusing its efforts on strengthening the relationship between the company and the academic world with a series of resources and activities, aimed at attracting talent, transferring knowledge and contributing to our society: research chairs, R&D+i projects, grants and internships for students, internal training for employees and support for young entrepreneurs. Many of the universities working with Iberdrola had a significant presence at Innoday.



In addition, during the event, several awards were given to young entrepreneurs who have developed disruptive projects for the energy sector in entrepreneurship events carried out by Iberdrola.

These include *Ecomapp*, an app developed by students from the Comillas Pontifical University and Iberdrola scholarship recipients which brings all electric mobility platforms together, and the *Future* project, in which students from the Monterrey Institute of Technology have developed a network of urban farms for sustainable cultivation managed using blockchain technology.

Students from the San Patricio School also received a prize — an award because Iberdrola not only collaborates with universities, but also wants to encourage entrepreneurship and innovation from school. For this reason, on 18-20 May 2018, the 9th edition of the San Patricio Foundation's Research, R&D and Innovation Congress was held at the Iberdrola Campus, where 120 students worked on innovation proposals, together with professional scientists, to foster their research spirit. Fostering technology and innovation among young people is one of the objectives of the Iberdrola Universities Programme and this sponsorship is a sign of Iberdrola's commitment to innovation, young people and entrepreneurship from very early stages.



On the occasion of this innovation fair, Onda Cero's *Más de uno* radio programme was broadcast from the Iberdrola Campus with the participation of Ignacio Galán. The Chairman of the group explained how Iberdrola is helping talented youngsters to learn so that they can innovate. He also talked about the company's achievements in recent years and the challenges that lie ahead.



INNOVATION Fair

Throughout the day, our innovation fair was held for the first time. It brought together Iberdrola's different business areas with suppliers and start-ups from five countries, creating a meeting point to present the solutions that each of them are offering for the different challenges faced by the energy sector.



Disruptive projects for the energy sector

During the fair, 25 exhibitors displayed their most innovative energy projects. These included both the group's own business areas as well as suppliers, customers, entrepreneurs, public administrations and start-ups committed to R&D+i development.

More than 600 Innoday attendees were able to see first-hand how, for example, we use drones to monitor our wind turbines or to see in situ how an electric car works. They also took a virtual trip to the Wikingen marine wind farm, operated by the company in the German waters of the Baltic Sea, and virtually visited the Cofrentes nuclear power plant. Measures to boost employee training and safety were also presented, such as a robotic arm designed to pick up objects from the pool of a nuclear power plant, and new customer-focused products such as the Energy Wallet, which allows customers to purchase energy packages.

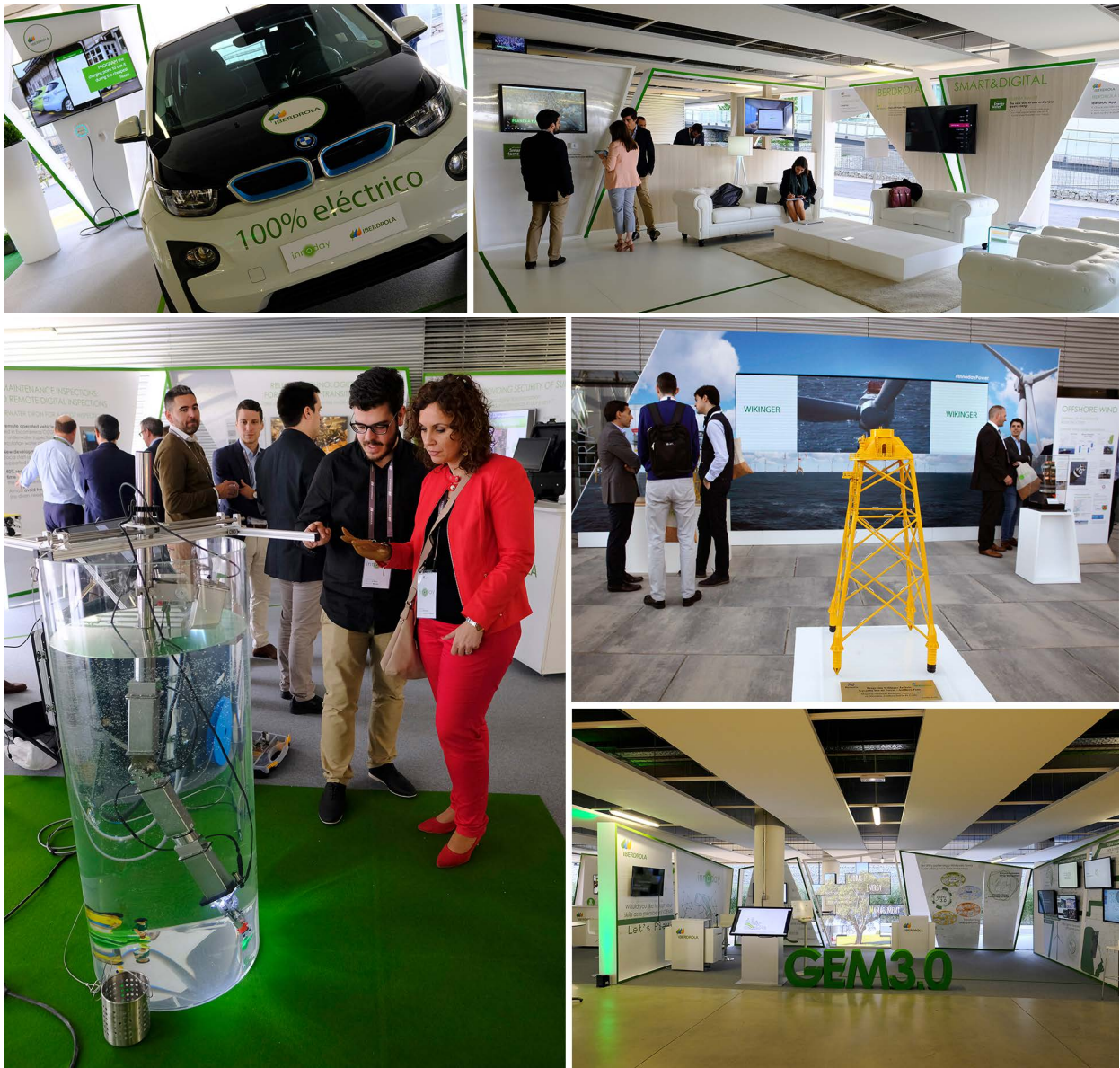

Moreover, some of our suppliers such as IBM, Ingeteam, Atlas Innovative Engineering and Árborea showed how they are responding to the challenges their businesses face within the energy sector. In this way, we continue to maintain our leadership at the technological forefront of the energy sector with the collaboration of our partners.



Formula Student Electric and MotoStudent Electric Spain

Iberdrola collaborates with the electric team at Comillas Pontifical University. In this project, more than 70 students, all of them members of the ISC Students Association, design, manufacture and assemble electric single-seater car and an electric motorbike for the Formula Student Electric and MotoStudent Electric Spain, respectively.

The initiative is designed to enrich the university students' theoretical learning with practical training, being a first contact in real engineering projects for students. These are some of the most interesting initiatives in the projects:

- **Formula Student Electric:** the goal is to design, manufacture and assemble an electric single-seater car to take part in the competition. The team competed at the Montmeló circuit in Barcelona in August 2018, where the vehicle's performance on the track was tested, as well as its response to static and dynamic tests. The students' business model was also evaluated.
- **MotoStudent Electric:** students developed parts of an electric racing motorcycle to take part in the Motorland circuit in Aragon in October 2018. Conceptual and detailed design, industrial product, the business case, acceleration tests and the performance in the race were among the aspects assessed.

The students designed a stand at Innoday dedicated to their electric team, which featured a car and motorbike chassis and an engine, batteries and wheels.



Speaker's Corner

Throughout the day, we got to delve deeper into the most disruptive and innovative projects being developed within our company at the *Speaker's Corner*. A space where Iberdrola employees presented the initiatives which are transforming the energy sector such as Smart Solar and Smart Mobility, projects re-

lated to renewable energies and smart grids, and the Iberdrola U Community. Also, prizes were awarded to the winners of the competition of innovative ideas launched by Social Networks.



At Iberdrola, we believe that innovation allows us to produce more and better energy for our customers, while generating wealth and employment through our purchases and investments.

Innoday 2018 has become a meeting place where excellence in the energy sector and the most innovative and sustainable practices come together, allowing us to continue progressing towards the utility of the future.



Iberdrola Innovation Middle East, a new technology centre

Ignacio Galán and Sheikh Abdulla bin Mohammed bin Saud Al-Thani, the president of the Qatar Investment Authority (QIA), opened the Iberdrola Innovation Middle East Center, Iberdrola's new R&D+i centre in Doha.

Focused on the challenges posed by the digitization of energy systems, the 'Iberdrola Innovation Middle East' is a new technology hub from which the company is developing innovation and consultancy services in three key areas: smart grids, system integration of renewable sources and energy efficiency.

Located at Qatar Science & Technology Park in Doha, the center aims at releasing new products and services for the digital utility, working at the intersection of energy and information and communication technologies.

Being fully aligned with the State of Qatar's innovation strategy, Iberdrola and its technology partners are committed to making an outstanding contribution towards fulfilling Qatar National Vision 2030 objectives, which guide the economic, social, human and environmental development of the country.

In addition to its important role as a base for research, 'Iberdrola Innovation Middle East' is tasked with serving as the central point of the Iberdrola group's activities in the Middle East.



Ignacio Galán at the inauguration of Iberdrola Innovation Middle East in Qatar





Innovative ecosystem: Entrepreneurship, start-ups and suppliers

Iberdrola is a pioneer in promoting innovation with start-ups, entrepreneurs and suppliers with the aim of developing new disruptive business models that allow us to guarantee our long-term sustainability, favour the exchange of knowledge and act as a driving force for our collaborators.

Iberdrola Ventures - Perseo Start-Up programme and entrepreneurship

The **Iberdrola Ventures - Perseo Start-Ups Programme**, endowed with 70 million euros, is aimed at promoting the creation and development of a global and dynamic ecosystem of emerging companies and entrepreneurs of the electricity sector.



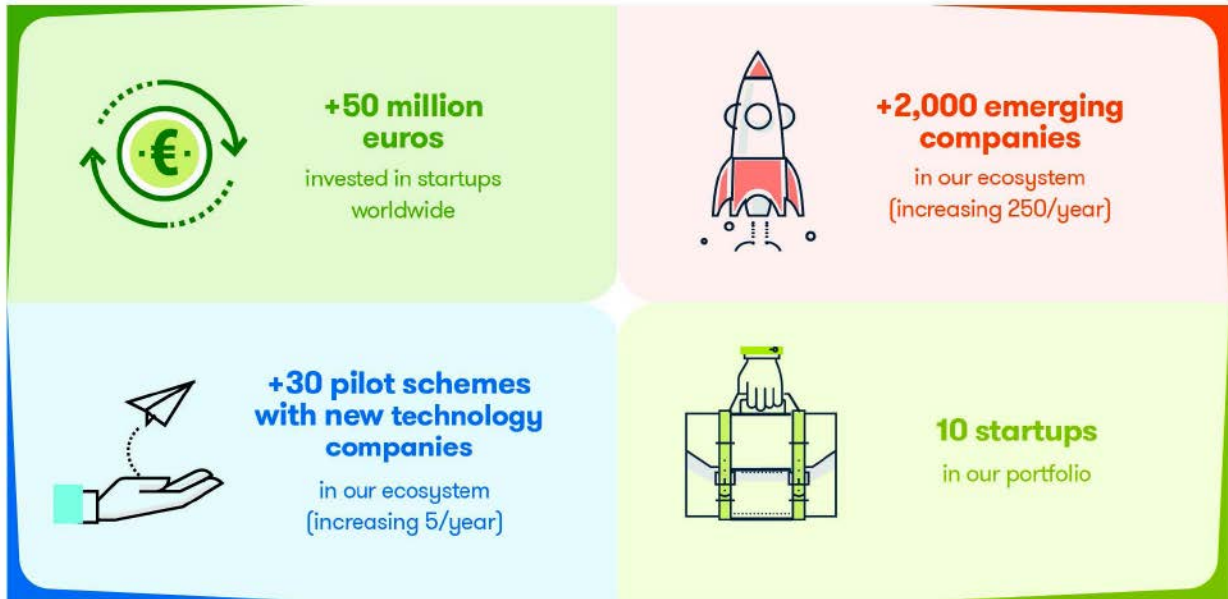

KEY FIGURES



It focuses on technologies and business models that improve the sustainability of the energy model through increased electrification and the decarbonisation of the economy.

Through this program, Iberdrola can provide startups, particularly in Spain, the United Kingdom and the United States, with its support as an investor, as well as its expertise, its base infrastructure, with 30 million supply points and its close to 50 GW of installed capacity. In this way, it contributes to developing and boosting an innovative corporate fabric in the energy sector.

Beyond the financial contribution, PERSEO's support for these companies has been key in defining their product and business model, providing them with Iberdrola's knowledge and access to the market. The work done with the start-ups has also served us as a technological antenna to find out where is sector is headed.

PROGRAMME OBJECTIVES	WHAT DO WE OFFER?
 <p>Early identification of key trends for the future of the company</p>	 <p>Access to the Iberdrola ecosystem</p> <ul style="list-style-type: none"> Access to market knowledge and key technologies A single point of contact
 <p>Access to groundbreaking technologies and business models</p>	 <p>Pilot schemes</p> <ul style="list-style-type: none"> Access to large volumes of data Testing of technology in a real setting
 <p>Encouraging an innovative, entrepreneurial culture</p>	 <p>Investment</p> <ul style="list-style-type: none"> Between 500,000 and 3 million euros (first rounds) Coinvestment with companies and risk capital funds

The programme's main lines of interest are:

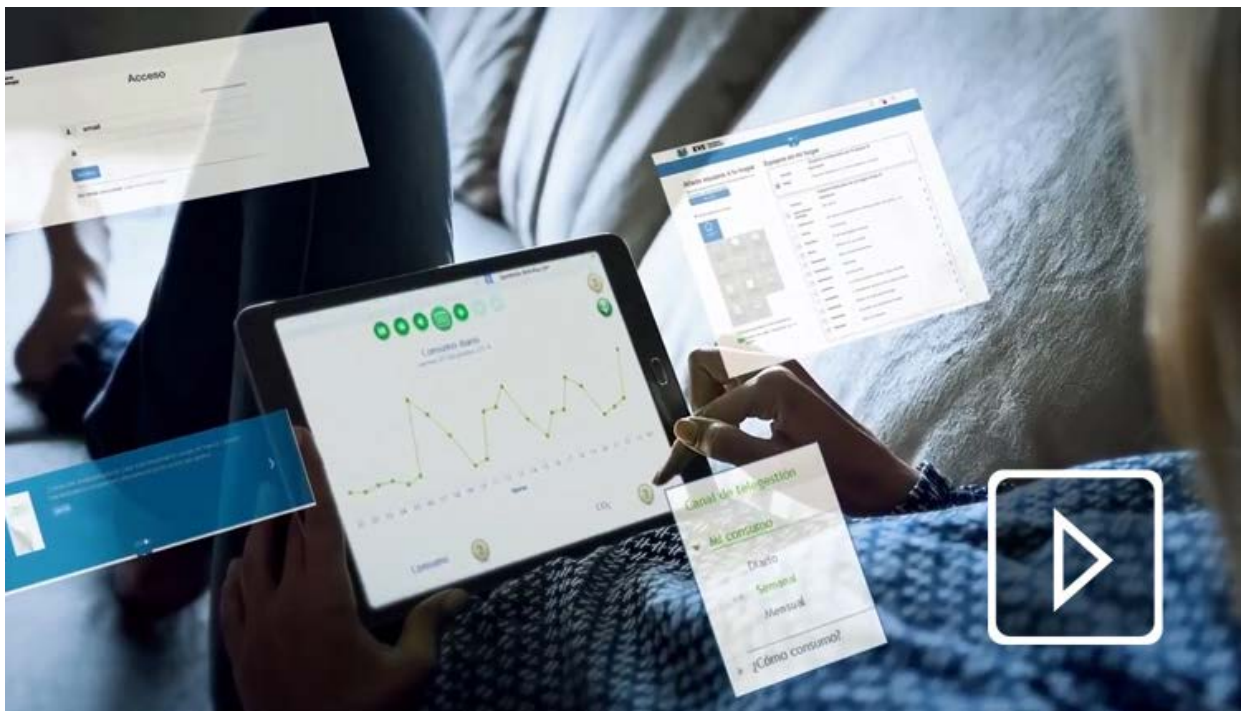
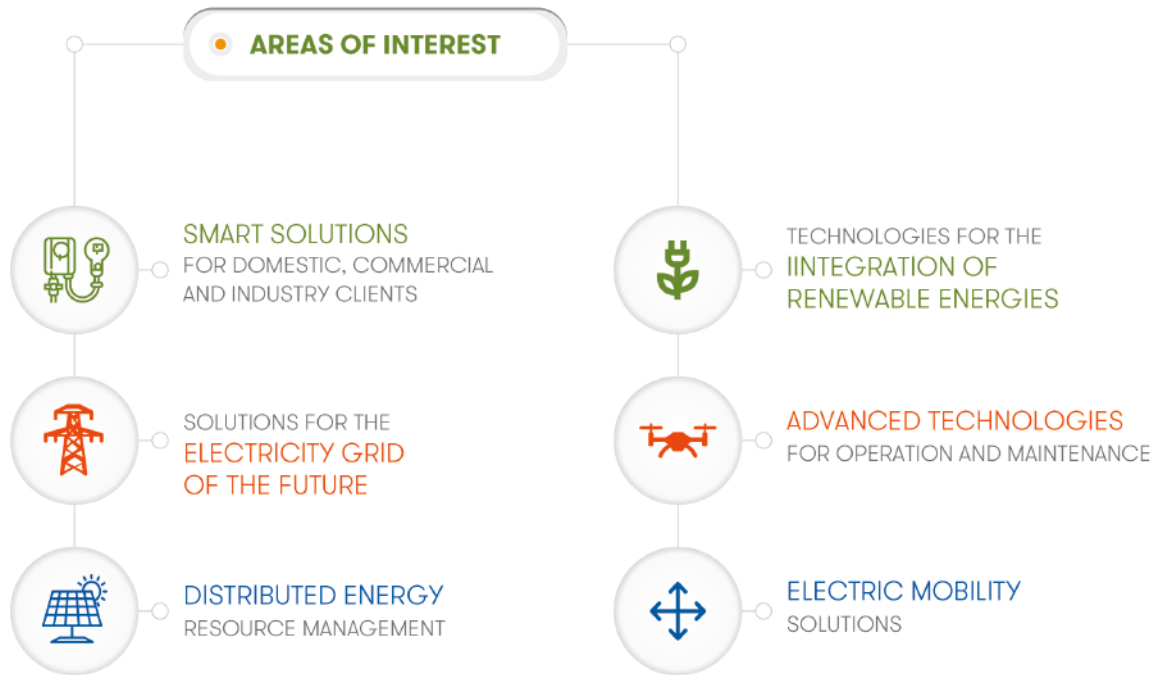

Investment portfolio

The **Iberdrola Ventures - Perseo Start-Ups Programme**, covers a wide range of national and international projects, in addition to other funding programs focusing on technology providers and projects with an important social component.

Here are some of the initiatives financed through PERSEO:



- **ARBÓREA INTELLBIRD:** The Arachnocoptero is a vertical take-off UAV (Unmanned Aerial Vehicle) capable of carrying a great number of electronic measuring devices, ranging from high-definition cameras to sensors for a broad range of civil and military applications. One of the company's main products, the Eol6, is a folding helicopter for the inspection of wind turbine blades. The use of the Arachnocoptero allows to reduce the inspection time, with minimum downtime and a great reduction of resources and logistics.

Iberdrola (through PERSEO) participates in Arb6rea Intellbird, based in Salamanca, through a co-investment with the Centre for Industrial Technological Development within the framework of the INNVIERTE programme.

- **ATTEN2:** The main activities of the Basque company Atten2, a spin-off of IK4-TEKNIKER and head-quartered at the Guipúzcoa Technology Park complex in Eibar, are centred around designing, manufacturing and retailing sensors for monitoring the state of fluids, particularly lubricants, in industrial applications.

Its products allow several lubricant parameters to be measured, including degradation, improving the operation and maintenance of electrical machines and optimising the use of lubricant. Iberdrola (through PERSEO) holds a stake in Atten2 through a co-investment with the Centre for Industrial Technological Development in the framework of the INNVIERTE programme.

- **GDES T4S:** Spin-off between Iberdrola and the Dominguis Group for streamlining the development of new technological products in the field of operation and maintenance of energy infrastructures. Nuclear and renewable energies are the priority intervention areas for GDES Technology for Services (GDES T4S). The purpose of the company is to create synergies in the field of technology for operation and maintenance in the electricity sector. The business model of the joint venture is to develop new products funded with capital from both partners, in which Iberdrola participates through Perseo.
- **ILUMÉXICO:** This Mexican company offers solutions for deprived communities, so they can have access to electricity using its solar energy systems. The company's participation is conducted through Iberdrola Ventures – Perseo.
- **INNOWATTS:** With its headquarters in Houston, Innowatts offers software solutions based on artificial intelligence and big data to facilitate the digitisation and automation of processes in the energy sector, contributing to improving efficiency and reducing the costs of the electricity system.
- **MORGAN SOLAR:** Morgan Solar Inc. develops high-concentration photovoltaics (HPVC), which have high efficiencies and low costs.
- **STEM:** Californian company Stem offers energy storage solutions that combine predictive analysis, cloud computing and big data with batteries to improve facility energy efficiency for commercial and industrial clients.

Stem has secured distributed storage contracts including the 85 MW being provided for Californian utility Southern California Edison.

In addition to Iberdrola, other large corporations have also joined its shareholding structure, including General Electric, Total and Constellation Energy.

- **SUNFUNDER:** Created in San Francisco and with headquarters in Washington DC and Nairobi, Kenya, SunFunder specialises in funding solar power projects in emerging markets, where more than 2.2 billion people live without access to reliable sources of energy.

Pilot projects with Start-Ups

As part of the Start-Ups programme, Iberdrola has conducted pilot projects with companies that have developed new technologies or solutions within the programme's areas of interest. Every year, Iberdrola develops more than 10 pilot projects with start-ups to test technologies for evaluating the feasibility of implementing them within the business.

In 2018, pilot projects were conducted in the areas of Renewables, Networks, Commercial and Generation, involving technologies like AI, machine learning, IoT and blockchain.

Other initiatives to promote Innovation and Entrepreneurship

IMPACT INVESTING

Through this line of action, Iberdrola invests in projects with a strong social component, with two main objectives:

- Employment generation and the creation of innovative companies.
- Facilitating universal access to electricity as part of the Iberdrola "Electricity for all" programme.

One of Iberdrola's main Impact investments is our participation, through the international Iberdrola - PERSEO Start-Ups programme, in **NEOTEC**, the Spanish venture capital program with the goal of fostering and developing innovative companies in Spain. As one of the main institutional investors, with a pledged investment of €10 million, Iberdrola is a permanent member of the Fund's Advisory Committee and an observer member of the Investment Committee on a rotating basis.

Under the **'Electricity for All'** programme, the international Iberdrola - PERSEO Start-Ups programme has invested in SunFunder, a company that has created a financing platform for investors and corporates to participate in a diverse portfolio of projects to promote access to electricity in developing countries in Africa, Latin America and Asia. It has also invested in **Iluméxico**, which provide access to electricity through solar power to the most disadvantaged communities.

Participation in other funds

In addition to the foregoing, Iberdrola participates in the following regional funds:

- Seed Capital Bizkaia in the Basque Country, whose mission is to promote and develop new or existing companies that intend to develop innovative projects, new products, markets or production processes, improvements in management, stability or continuity, future projection, stable job creation and wealth generation.
- ADE Sodical in Castile and Leon strives to develop businesses in Castile and Leon by providing financial resources to companies, seeking the most appropriate formulas for each project and, especially, participating in the share capital, granting equity loans and other alternative funding instruments.
- RICARI in La Rioja aims to collaborate in developing and strengthening economic and industrial activity in La Rioja while providing support for new business initiatives. Its goal is to work closely with the company as a partner and not merely a funder by providing strategic and management assistance without interfering with the company's day-to-day activities. Ricari seeks to maintain a close, constructive and continual dialogue with shareholders and the management team as a temporary partner, remaining amongst the shareholders for approximately 3 to 6 years.
- Avante in Extremadura furnishes services to companies and economic agents with a view to helping them contribute to the economic and social development of Extremadura in partnership with the regional government of Extremadura for executing its corporate policies.
- Extremadura Business Corporation: this entity provides backing for feasible and profitable initiatives that contribute to strengthening the business fabric in Extremadura.

Other Initiatives

Iberdrola also collaborates with other forums, associations and meetings to encourage entrepreneurial activity, including:

- As partner of the Spanish Venture Capital Entities Association (ASCRI), Iberdrola is actively involved in its venture capital committee, which seeks to promote investment at the earliest stages [entrepreneurship].
- As partner of Innobasque, Iberdrola is a key member in the Cleantech INNvest investor network, promoted by Innobasque in the Basque Country.
- Iberdrola also sponsors a range of congresses and events in the field of entrepreneurship.

Awards

For the second year in a row, Iberdrola has been recognised by the European Commission as being one of the European corporates that does the most to support start-ups. In 2018, Iberdrola was named one of Europe's Top 12 Corporate Startup Stars, the only Spanish company in the category. We also received our second special mention in the Startup Procurement Award category, for technological pilots and purchases placed with start-ups.

Supplier Innovation Programme

Iberdrola also deploys other programmes to develop R&D+i through collaborations with its partners such as the Supplier Innovation programme, whose main objectives are to:

- Facilitate access to financing mechanisms.
- Promote the creation of joint ventures (spin-offs with suppliers).
- Encourage innovative purchasing from SMEs.



Within the framework of this programme, Iberdrola (through its Perseo investment fund) has created, together with the Dominguis Group, a new company called **GDES T4S**, through which various collaborative projects are being developed to improve operations and maintenance at nuclear plants:

- **OFF-GAS**, a project to develop a system for monitoring the integrity of the reactor fuel and control rods of nuclear power plants through the continuous measurement of discharge gases.
- The **FILTRABIS** project, which aims to develop and build an aspiration and filtration system to analyse and classify disposable materials from nuclear plants.
- **RESHAND**, a project to design, develop and construct equipment allowing access to different elements located within the containment pools of the nuclear power plant. The aim is to increase operational safety and reduce risk for operators.

Innovation Program with Suppliers Iberdrola Bizkaia



In 2017, Iberdrola collaborated with Beaz to launch a special line of the Innovation Program with Suppliers Iberdrola-Bizkaia endowed with 1M€. The objective is to finance the development of innovative projects from Bizkaia-based suppliers, allowing them to develop new products and services in the energy sector and contribute to developing the industrial network of the province.

Following the announcement of this programme on 20 July 2017 to **70 suppliers and the Bizkaia Provincial Council** at Iberdrola Tower in Bilbao, 22 proposals were received. So far, two projects have been financed:

- The project by the supplier AFESA, “Development of dismantling and declassification procedures for tubular beams in condensers in nuclear plants”, which aims to recycle as much radioactive waste as possible and minimise the amount that needs to be stored.
- Ingeteam Power Technology’s project, “Development of unitary distributed protection of rods and breaker failure” (UNIBUS), aims to provide an interoperable unitary protection solution to protect high- and medium- voltage levels using process bus protocol, a big technological leap forward compared to existing equipment on the market.



Other Initiatives

Nova Energia Challenge

Startup challenge for energy efficiency

Neoenergia launched this industry innovation challenge in 2017. It is a great opportunity for investors and large and medium-sized companies to connect with small industrial companies, individual entrepreneurs and technology-based start-ups in order to develop innovative products or processes of mutual interest. This initiative forms part of the Energy Efficiency programme regulated by Aneel.

It involves three challenges;

- The first is related to reducing consumption and encouraging the rational use of electricity. The objective is to educate citizens about rationalising energy consumption while seeking solutions to improve control over and eventually reduce the consumption of energy in residential, industrial and commercial facilities.
- The second relates to distributed generation, and the aim is to reduce the environmental impact, minimise losses and reduce stress on the system. With the objective of improving energy efficiency, this challenge is aimed at finding new technology solutions and applying them to consumption management and distributed generation in a feasible and effective way.
- The third relates to technology for education, encouraging students to increase their participation. Introducing more technology into the teaching process will improve the student-teacher relationship as well as students' grades and development.



Solar tree challenge

University students took on the solar tree challenge.

After launching the solar tree challenge, 24 teams were organised to build a prototype solar tree, a tree-shaped sculpture designed to generate photovoltaic solar energy and provide public lighting, wifi and free mobile charging. The project also sends out messages on the reduction and rational use of energy with the aim of promoting energy efficient habits. This initiative forms part of the Energy Efficiency programme regulated by Aneel.



HALO Project

ScottishPower gets involved in an ambitious urban renewal project

Recently, and with the aim of renovating a former industrial site in Kilmarnock in Scotland, ScottishPower and The HALO organisation have joined forces in a five-million-pound, five-year project to convert the old facilities into a unique urban park with a dynamic commercial, educational, cultural, leisure and lifestyle quarter.

ScottishPower will be the main partner in this imaginative, ground-breaking and inspiring urban renewal initiative, and is participating in the creation of a cyber and digital learning facility based on the concept of "the power company of the future". It is hoped that this will put the site at the forefront of the "Fourth Industrial Revolution" in this region, which has traditionally been associated with industry.

The unique alliance between ScottishPower and The HALO will also explore energy innovations to reduce carbon emissions and will harness the business and technical experience in our company to support start-ups located at the new site.

As well as regenerating the area, The HALO initiative seeks to enhance economic growth and provide employees with advanced digital and cyber skills, through an innovative collaboration with the Scottish Business Resilience Centre, Ayrshire College and Scottish universities, where accredited courses will be created. The agreement involves support from ScottishPower for employability initiatives through specialist technical input into student learning and practical skills development to enhance the job prospects of local young people.



Collaboration with other universities

Iberdrola is working on ensuring universal access to energy services, boosting knowledge in specific areas of science, energy and information technology and R&D+i projects, in collaboration with universities and institutions.

As mentioned, the company has an open and decentralised R&D+i management model featuring the participation of technology suppliers, universities, foundations, technology centres, industrial organisations, etc. through different programmes and chairs.

These special collaborations are significant ways of:

- Promoting University-Business-Society knowledge transfer.
- Promoting the launch of R&D+i projects in areas like smart grids, alternative energies, renewables and universal access to energy services.
- Promoting specialised training in fields of greater interest to Iberdrola.
- Materialising our social commitment through affordable and inclusive funding models.

The existing agreements and the main actions carried out are described below.



Orkestra Energía Chair (Basque Institute of Competitiveness) – Deusto Foundation

ORKESTRA is an initiative launched by the Basque Institute of Competitiveness, which belongs to the Deusto Foundation, an organisation devoted to transferring scientific knowledge to society. Through this organisation, Iberdrola participates as a trustee in the Energy Chair, which works around four areas:

- Energy and market economy: analysing the context of the most relevant aspects of international and national energy markets as well as examining energy generation technologies and the incorporation of environmental and/or energy policy requirements.
- Transport and energy: based around four aspects: the current situation from a national and regional standpoint, energy consumption for overland transport and future technologies for transport.
- Energy, technology and industry: competitiveness and industrial development, to study energy supply as an input from an industrial standpoint, analysing the role of energy within business competitiveness, following the “diamond model for competitiveness” and “clustering” as well as the potential effects in connection with the incorporation of new energy technologies and the creation of new companies or businesses.
- Energy geopolitics: analysing the context of energy from a geopolitical standpoint. Examining the current level of dependency on hydrocarbons and the consequences for the energy model, and possible ways to address the challenges arising from energy dependency.

It thus seeks to provide elements for debate in order to propose solutions to providing cost-effective and environmentally sustainable energy, thus contributing to competitive and industrial development.

Iberdrola-UPM Chair for Sustainable Development Goals



This chair responds to the international community's call to governments, private companies and civil society to join forces with a view to increasing global access to modern forms of energy, with environmentally sustainable, economically viable and socially inclusive supply models. Iberdrola and the Polytechnic University of Madrid (UPM), through its Centre for Innovation in Technologies for Human Development, join forces to train, disseminate and identify possible R&D+i actions that give rise to innovative projects in the field of universal access to energy services.

King Felipe VI Endowed Chair in Information Technology and its applications



Iberdrola created the King Felipe VI Endowed Chair in Information Science and Related Technologies (formerly known as the Prince of Asturias Chair) in 2000 at the University of New Mexico, Albuquerque, with the support of the Spanish Ministry of Science and Technology.

The chair was created primarily with a view to furthering research and advancing knowledge in specific areas within the fields of science, information technology and energy, preferably concerning smart grids and alternative and renewable energies. Likewise, the Chair aims to encourage collaboration within these areas between the institutions and communities involved, and act as a catalyst for significant collaboration between Spain, Latin America and the University of New Mexico.

Iberdrola Financial and Business Ethics Chair at Comillas Pontifical University

In 2018, Iberdrola and the Comillas Pontifical University created the Iberdrola Financial and Business Ethics Chair, which has the main aim of encouraging education and fostering the concepts and principles of business and professional ethics in all of its spheres.

This chair is the result of both institutions' commitment to best practices, and aims to be a meeting ground for academia and business in relation to this subject.

The agreement between these two institutions also includes activities to disseminate and raise awareness towards the research work and studies carried out, including seminars, meetings, papers and publications.



Julio L. Martínez, rector of the Comillas Pontifical University, and Ignacio Galán, chairman of Iberdrola

Iberdrola Manuel Marín Chair at the College of Europe

In 2018, Iberdrola announced that the European energy policy chair at the College of Europe will now be called the Iberdrola Manuel Marín Chair.

The aim of this chair is to teach, research and debate the energy policies within the European Union. The main activities promoted by the chair include teaching a subject on energy policy; organising high-level conferences with key players in the energy policy legislative process, as well as seminars and workshops; research work and, finally, fostering relations between European institutions and reference associations.



Ignacio Galán, chairman of Iberdrola (second from the right) with other participants at the tribute to Manuel Marín held by the UNED [Spanish National University of Distance Education]. From left to right, Nativel Preciado, Felipe González, Alejandro Tiana, Ana Pastor and Abel Matutes





Digital transformation

The roadmap of Iberdrola Group includes digitisation as one of the key elements to face with guarantees of success the future energy scenario



Iberdrola believes that **digitisation needs to be a priority for the company** as the electricity sector is now undergoing an unprecedented transformation in a social and economic environment increasingly open, digital and intelligent to meet the needs of increasingly demanding customers. The company therefore plans to invest 4.8 billion euros between 2018 and 2022, focusing on improving the operation and maintenance of its assets and increasing the availability of its generation plants.

Digital Roadmap 2016-2022

The digital strategy defined by Iberdrola must ensure the full integration of digitisation in all of the company's businesses so that the company stay at the forefront of industry in areas such as the energy transition and the digital transformation of society.

Iberdrola has preempted the energy transition by committing itself to a decarbonised and electric economy: more clean energies, greater storage capacity, more and smarter grids and increased digitisation.

With regard to the transformation of society, which is becoming more and more connected and digital, Iberdrola is committed to digitisation to safeguard one of its basic pillars: customer satisfaction, improving the user experience and offering personalised products.

To ensure the full deployment of the digitisation process, Iberdrola is encouraging a **culture of innovation at all levels**, defining new procedures and internal models, new customer relations protocols and new products and services.



As a result, the company has become a pioneer in using the digital transformation to improve competitiveness, customer loyalty, supply quality and operational efficiency. By 2017, Iberdrola had invested €5.6 billion in digitisation and the company's digital plan for 2022 aims to boost turnover with an investment of 4.8 billion euros (75 innovation projects per year).

NOE / Gross Margin (%)

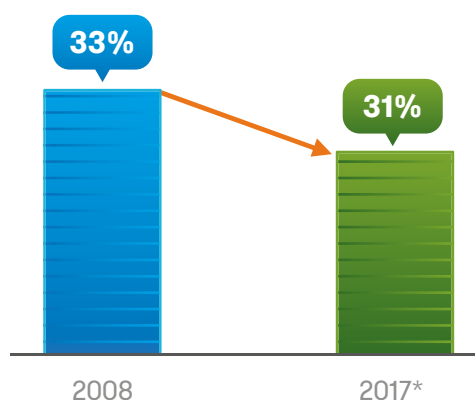

* 2017 impacted by negative hydro conditions and restructuring costs

EUR 5.6 Bn invested in digitalisation in the past years

- ✓ Centralised assets management (DCG, CORE, CODs)
- ✓ 100% automated Generation
- ✓ O&M: Independent Service Providers, drones...
- ✓ 13 Million Smart Meters
- ✓ 100% automated HV grid in Spain, UK and Brazil, 80% in USA
- ✓ 100% automated customer back office

50 Innovation projects / year

NOE / Gross Margin (%)

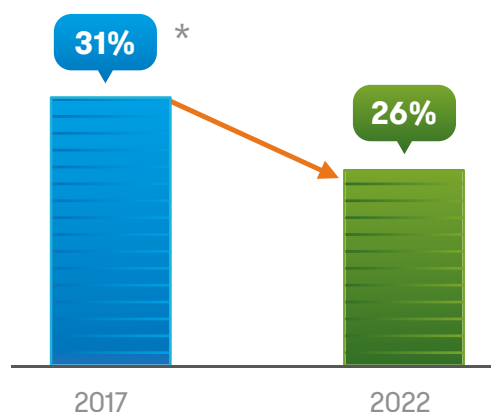

* 28% in a 2022 like for like basis

EUR 4.8 Bn investments in digitalisation

- ✓ Predictive O&M: data analytics and AI
- ✓ Improvement in generation availability
- ✓ 20 Million Smart Meters (100% Spain, UK and USA)
- ✓ 100% automated HV grid in USA
- ✓ Early detection of fraud, losses and grid faults
- ✓ DSO functions
- ✓ Digitalisation of customer front office

75 Innovation projects / year

In addition, between 2018 and 2022 a **new global IT security and cybersecurity plan** will be launched with the aim of effectively securing critical assets and processes, improving grid access control and data security, and preventing intrusions.

INFORMATION TECHNOLOGY (IT) APPROACH

<div style="text-align: center;">  <h3 style="color: #D9534F;">INNOVATION AND DIGITAL TRANSFORMATION</h3> </div> <ul style="list-style-type: none"> • Initiatives related to smart metering programs • Big data and analysis tools • Development of new products and services for retail customers • Improved asset lifecycle management 	<div style="text-align: center;">  <h3 style="color: #4F8127;">EFFICIENCY</h3> </div> <ul style="list-style-type: none"> • Adoption of the highest technology standards for cloud-based IT services, our mobility services, and for improving infrastructures
	<div style="text-align: center;">  <h3 style="color: #4F8127;">GLOBAL IT AND SECURITY PLAN</h3> </div> <ul style="list-style-type: none"> • Effectively guarantee critical assets and processes • Improved control over grid access and data security • Enhanced intrusion prevention

Iberdrola expects digitisation-related initiatives to generate an EBITDA of 600 million euros by 2022. This contribution will be made possible by operational improvements, process transformation and new products and services.

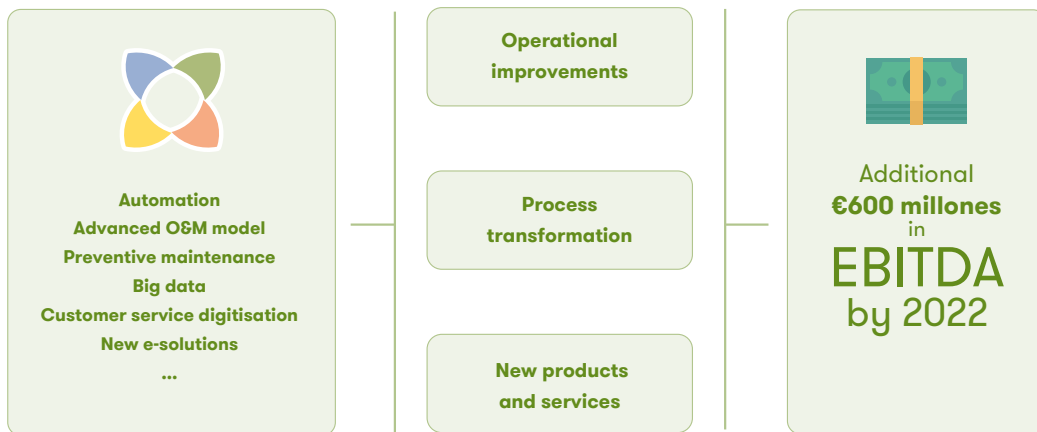

Technological Pillars of the Digital Transformation

The main areas on which Iberdrola focuses to implement digitisation are:

- **Digital culture:** through initiatives including training and providing equipment to employees, process acceleration groups (Next and Accelerator), and management procedures, processes and apps.
- **Asset management:** Real-time remote control, predictive maintenance and operational efficiency from generation to distribution.
- **Grid optimisation:** Promoting the development of smart grids, integration of renewable energy sources, improved supply quality and the installation of smart meters.

- **Geographic information systems:** Supply point management, control of distribution lines and transformer substations and participation of different profiles and through different channels in a single business process.
- **Innovative customer-oriented solutions:** Customised energy solutions: Distributed generation and storage, connected home, new innovative energy products, demand management, green mobility, energy efficiency and savings, personalised, multi-channel and personalised communication, green mobility and electric vehicles.

To this end, Iberdrola is leveraging the following technologies in order to digitise its assets, workforce and customers:



The Internet of Things

We are using the **Internet of Things** to **connect objects intelligently** and thanks to this connection we can:

- Improve occupational safety by installing sensors in personal protective equipment.
- Inspect the condition of power lines with thermographic cameras.
- Maximise the efficient use of common areas in buildings through sensors.



Augmented and virtual reality

Augmented Reality and Virtual Reality tools and applications help us to **improve safety and operability**: their installation on mobile devices assists in operations on overhead and buried lines and the gas transport network.

Virtual and augmented reality is also used to visualise danger warnings in maintenance areas in real spaces or on 3D models of power plants.



Artificial intelligence

Artificial Intelligence allows us to **achieve excellence in customer service** with virtual assistants, advice on buying products and services on the web, as well as facilitating the work of agents in our call centre.

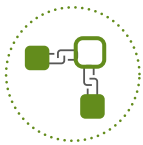

Blockchain

We use **blockchain technology** to **secure electronic transactions** and smart meters against cyber attacks, streamline and certify contracts between group companies and, among other applications, **certify the origin of renewable energy**.

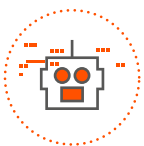

Machine learning

We are developing computer learning techniques (machine learning) to **improve customer care by telephone**. These techniques are also helping us to:

- Provide knowledge management solutions to control high turnover environments and minimise the impact on call centres.
- Break down the consumption measured by smart meters personalised to individual energy use or by identifying the category of electrical appliances.



Robotics

Robotics allows us to **perform smart operations by automating processes**. We also use it to automatically monitor changes in gas import prices in the Global Energy Management Area, as well as to support administrative procurement processes.



COGNITIVE SOLUTIONS

Cognitive solutions serve to **improve first level customer service responses**, increase the intelligence of virtual assistants and test combined **biometric techniques** to ensure a person's authenticity through a mobility device.



DIGITAL ANALYTICS

Digital analytics allows us to **create analytical environments to generate the knowledge** used to support the Distribution, Renewables and Commercial businesses, as well as to undertake new research on all our commercial and operational processes.



SMART MOBILITY

We are using different disruptive technologies to **automatically generate Smart Solar's personalised offer and to contract and monitor installation and consumption**.

Apps, for example, enhance the user experience, easily reporting interruptions in supply, power cuts, and allowing information to be received, viewed and searched.

They also serve to create the energy wallet that manages customers' energy accounts globally and to build customer loyalty and an enhanced user experience.

Digital Initiatives

Iberdrola has taken important steps to position itself at the forefront of the digital transformation, conducting numerous R&D projects which have increased efficiency, security and reliability in all Group businesses:



In addition to the **R&D projects developed within the area of digitisation**, Iberdrola is taking part in proofs of concept and multi-sector work groups with the aim of continuing research into the practical application of new disruptive digital technologies. The most significant actions are detailed below:

Proof of concept of peer-to-peer (P2P) wholesale trading platform using blockchain technology

Iberdrola is one of 41 participants taking part in the Enerchain project, led by Ponton, an EFET (European Federation of Energy Traders) technological partner. Enerchain aims to create a blockchain-based wholesale P2P trading platform for energy products.

The software used, Enerchain, allows operations to be conducted peer-to-peer, without the need for an intermediary. Through the use of Blockchain, the main aim is to reduce external and internal costs per transaction, minimise counterparty risk and increase levels of IT security and redundancy at lower cost.

By **being involved in the project from the initial stages**, we have a **privileged position** in the final configuration of the platform and are increasing our **in-house knowledge of P2P trading platforms and blockchain.**

At the ETCSEE (Energy Trading Central and South Eastern Europe) Conference held in Prague in June 2017, **Iberdrola closed the first ever wholesale energy purchase operation in southern Europe to be undertaken using blockchain.** The other party in the operation was French energy company Total, and the product traded was day-ahead electricity.



Figure 4. Enerchain trade at ETCSEE

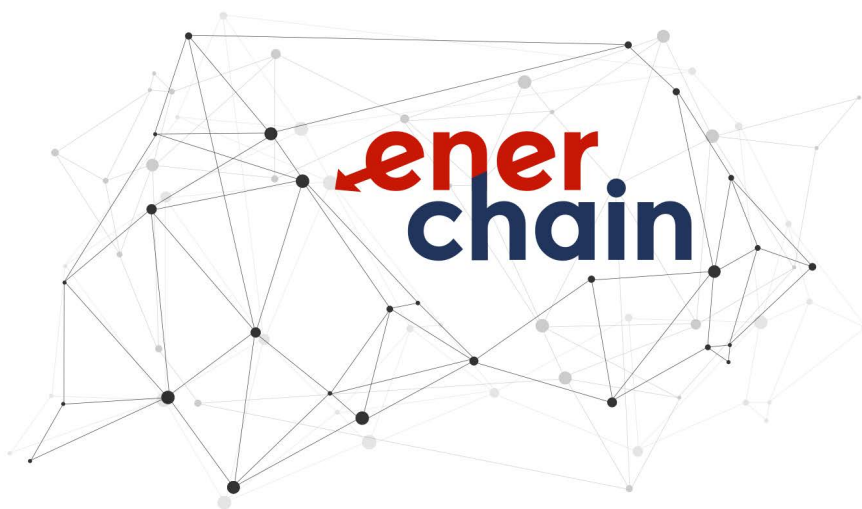



Expert discussion platform on blockchain at Eurelectric

EURELECTRIC has brought together a group of experts to research how blockchain can be applied along the electricity value chain. Three areas of action have been defined: Electromobility, Flexibility and Trading, in which all aspects will be discussed jointly with the end goal of publishing reports which respond to the biggest questions about the application of blockchain in the electricity sector.

Since the end of 2017, several reports have been published:

- At the end of November 2017 a **report** was published focused on the area of **electromobility**.
- On 3 May 2018, two white papers were published:
 - *Blockchain in Electricity: a Critical Review of Progress to Date.*
 - *Blockchain in Electricity: A Call for Policy and Regulatory Foresight.*



Alastria

Iberdrola is part of Alastria, a national not-for-profit multi-sector blockchain consortium which aims to **promote a semi-public permissioned blockchain network that supports services with legal effectiveness in Spain and in accordance with European regulations.**

The consortium includes companies from a wide range of sectors, such as banking, markets and insurance (Santander, BBVA, Sabadell, Bankia, BME, Mapfre, CriptoPay, etc.), as well as utilities and industry (Iberdrola, Endesa, Gas Natural Fenosa, Cepsa, Correos, REE, Repsol, EDP, etc.), telecoms (Telefónica, Vodafone, Orange, etc.), services (Everis, Garrigues, Cuatrecasas, IBM, Indra, SAP, Microsoft, Deloitte, etc.), and universities and other non-profits (ICADE-ICAI, Politécnica de Barcelona, Asociación Española Fintech, Asociación Española de Banca, Foment, etc.). So far, there are more than 300 companies. Recently, the consortium welcomed its first public sector member, the Spanish Public Treasury.

Iberdrola Innovación, together with the Systems area, have actively participated in this platform, the only one of its kind in the world, from the early stages, and are present in several of the committees that have been set up (Technical, Legal, Identity, Communication, Innovation and Talent, and Universities and Members).

The partners participating in the project enjoy the advantages of having **an infrastructure** to provide blockchain products and services to our customers **within a regulated environment** (Spanish domain, in accordance with European regulations), the chance to participate in its design and operate a validator or observer node, as well as an innovative position, pre-empting future interest in blockchain technologies.



Energy Web Foundation

Iberdrola is a member of the **Energy Web Foundation**, along with other organisations in the energy sector. Energy Web is a scalable, open-source **blockchain platform**, specifically designed to cover the regulatory, operational and market needs of the energy sector. It is used as a shared digital infrastructure for the energy and blockchain communities to build and manage their solutions.

Together, the Energy Web Foundation, affiliates and the community are unleashing blockchain's potential to accelerate the transition to a decentralised, democratised and decarbonised energy system.

Four areas of work have been identified:

- Certificates of origin
- Billing
- Demand management
- Transactive energy

Energy blockchain Hackathon

From 3 to 5 December, Iberdrola took part in the *Energy Blockchain Hackathon* held in Berne. The event was organised by the *Energy Web Foundation*, Iberdrola has been a member of the foundation since June 2018.

Iberdrola presented a use case to increase market confidence in distributed generation through the use of blockchain technology.

The challenge presented by Iberdrola consists of developing a blockchain-based system to generate a decentralised and reliable register of production equipment. This register will ensure and validate the equipment's functioning without the need for each device to be checked by an independent body. The system will also provide reputation scores for each producer that will penalise fraudulent behaviour, helping maintain the integrity of the system as a whole.







Innovation in products and services

New customised products and services that meet the challenges of the new energy model

The rate of adoption of new digital technologies and services has transformed consumers, who have developed new habits in their personal and professional lives, and also in the way they relate to businesses. It is vital to systematically seek out new ways and channels for interacting with customers as well as to develop new business models.

It is also crucial to design new products and services that make the company both appealing and unique. And to develop new management and operating processes and systems that guarantee an efficient, agile and quality service, capable of satisfying the increasing demands of users at a competitive cost.

In this regard, **Iberdrola has already designed unique products and services for its 16 million customers**, complying with four fundamental requirements:

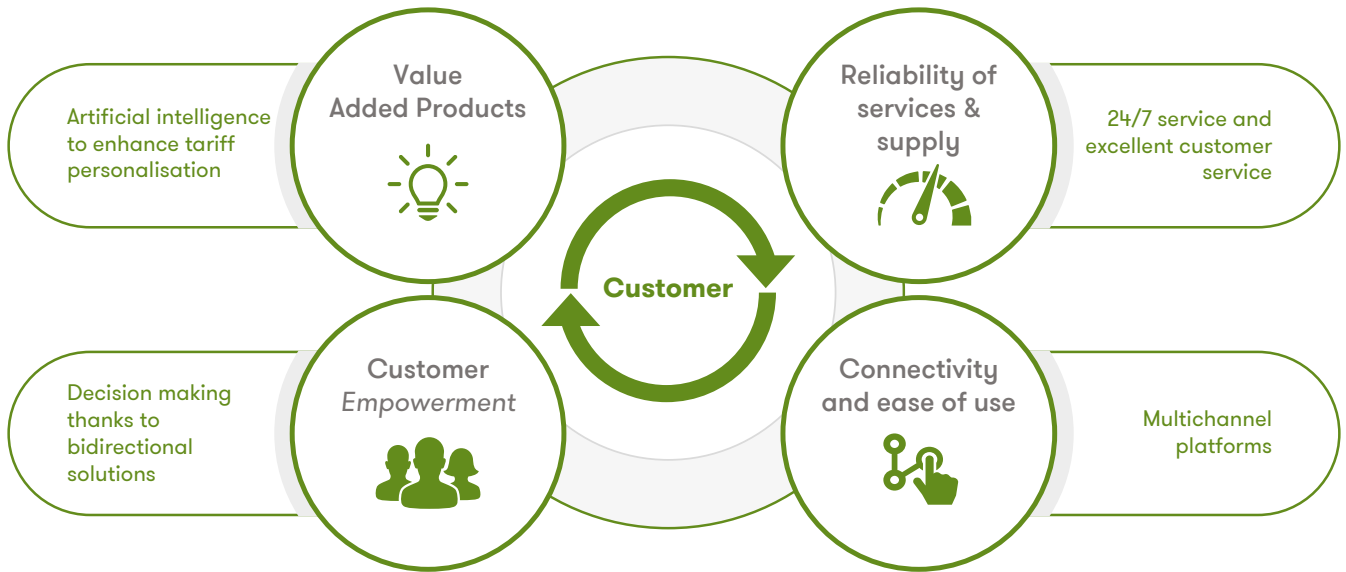

The most significant of these are described below by area:



Decentralised energy generation

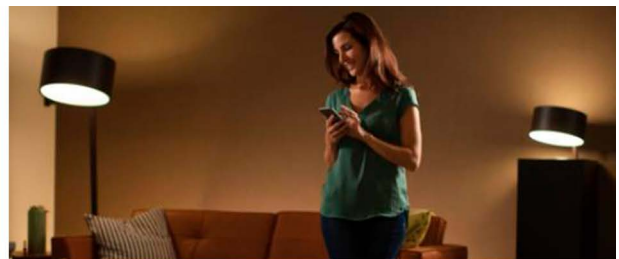

Smart Home



Customised electricity Plans



Smart cities and mobility

Decentralised energy generation

A comprehensive solar solution to generate and use your own power

Smart Solar Iberdrola is a comprehensive solution that lets our customers generate and consume their own photovoltaic energy and save on their electricity bills. This service includes custom design, assembly and all legal permits for a solar photovoltaic installation, as well as access to financing and advice on insurance, maintenance, and online monitoring.

This solution is aimed at allowing domestic customers, SMEs and large companies to generate and consumer their own electricity, optimising their consumption and improving the energy efficiency of their installation. Iberdrola provides a full customised assessment to find out which solution best adapts to the customer's needs.

The service offers several advantages:

- **Design:** Using our online quotation tool, in less than 2 minutes our customers can calculate the optimal photovoltaic installation for the size of their roof and their consumption behaviour.
- **Quality:** Iberdrola only works with the highest quality equipment and cutting-edge technology. All equipment installed is of proven quality and guaranteed to function throughout the contract period.
- **Maintenance and Breakdown Service:** Iberdrola offers a maintenance service to ensure that the installation is always in optimum operation condition. We offer clients round-the-clock service to resolve any issues.
- **Web Services:** Access to the Customer Dashboard, a web platform where our customers can check the status of their installation in real time.

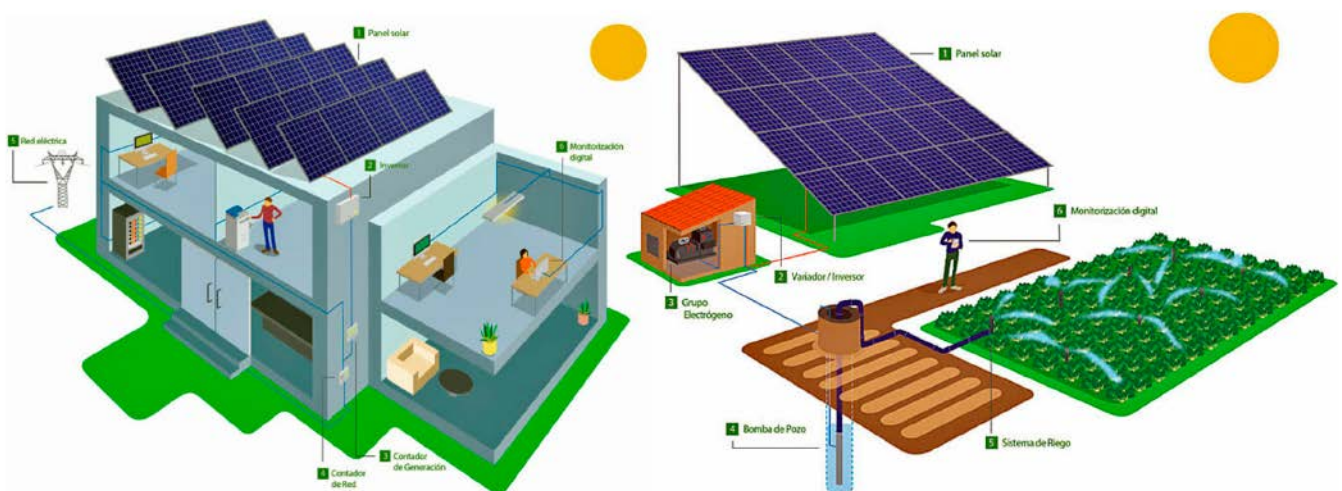

Smart home

Iberdrola focuses on improving energy management allowing devices connected to the internet to give customers better knowledge of the energy consumed and even the ability to manage such consumption and achieve energy savings.

- The **Iberdrola Smart Home** platform allows the efficient management of energy in the home using smart devices such as: Smart Thermostat, to control your heating and its temperature no matter where you are: (mobile, tablet, computer, etc.); smart consumption monitor, a wireless electricity meter that lets you see how much energy your household appliances are consuming in real time., Smart lighting, smart LED bulbs which can be controlled from your mobile; Customers can use their mobile or tablet to control and monitor the functioning of all of these elements, which are all available from Iberdrola.

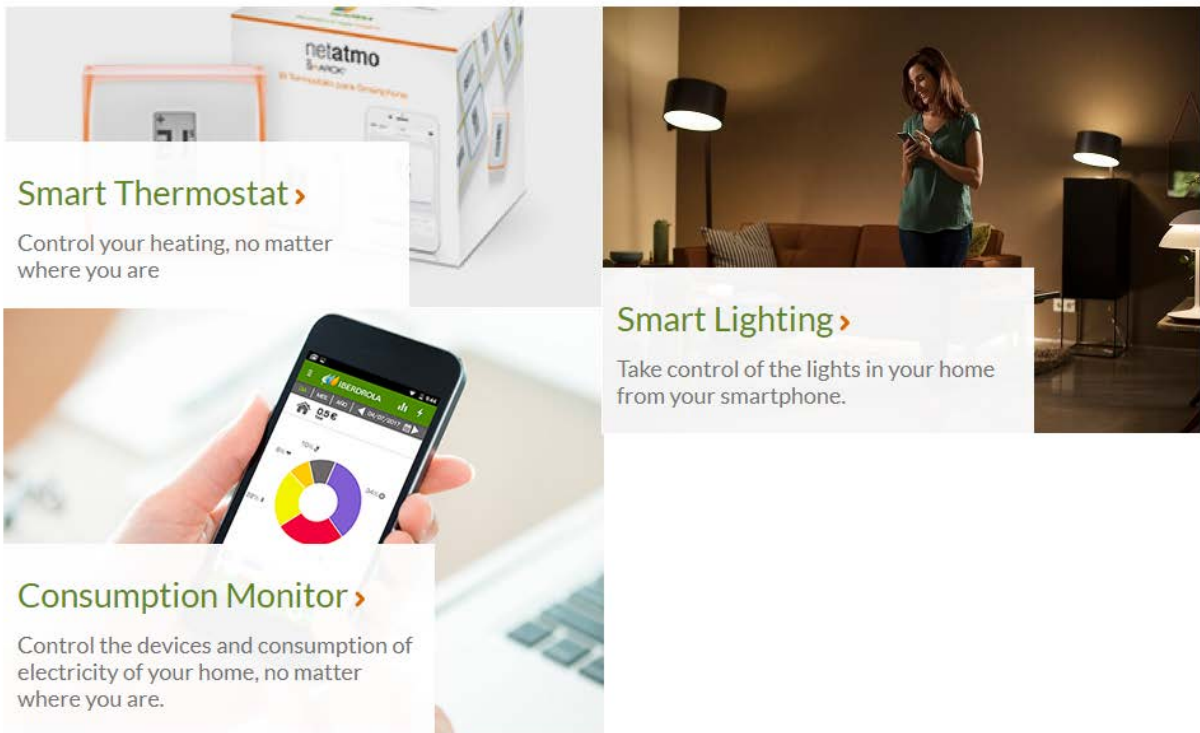

- **ScottishPower has created PowerUp**, an application that allows customers to buy energy (gas and electricity) using their mobile according to their own needs. The tool offers packages on a daily basis or for one, three or six months, and allows you to view how much energy you have consumed and how much you have left. Customers can monitor their usage through a new application, which will show them, in an easy-to-understand way, how much they are spending in relation to their consumption and how much they are paying each day. There are no standing charges for customers who pay using PowerUp, so if no energy is used on a given day, there will be nothing to pay. ScottishPower has also simplified its billing to help its customers understand and manage their energy consumption.

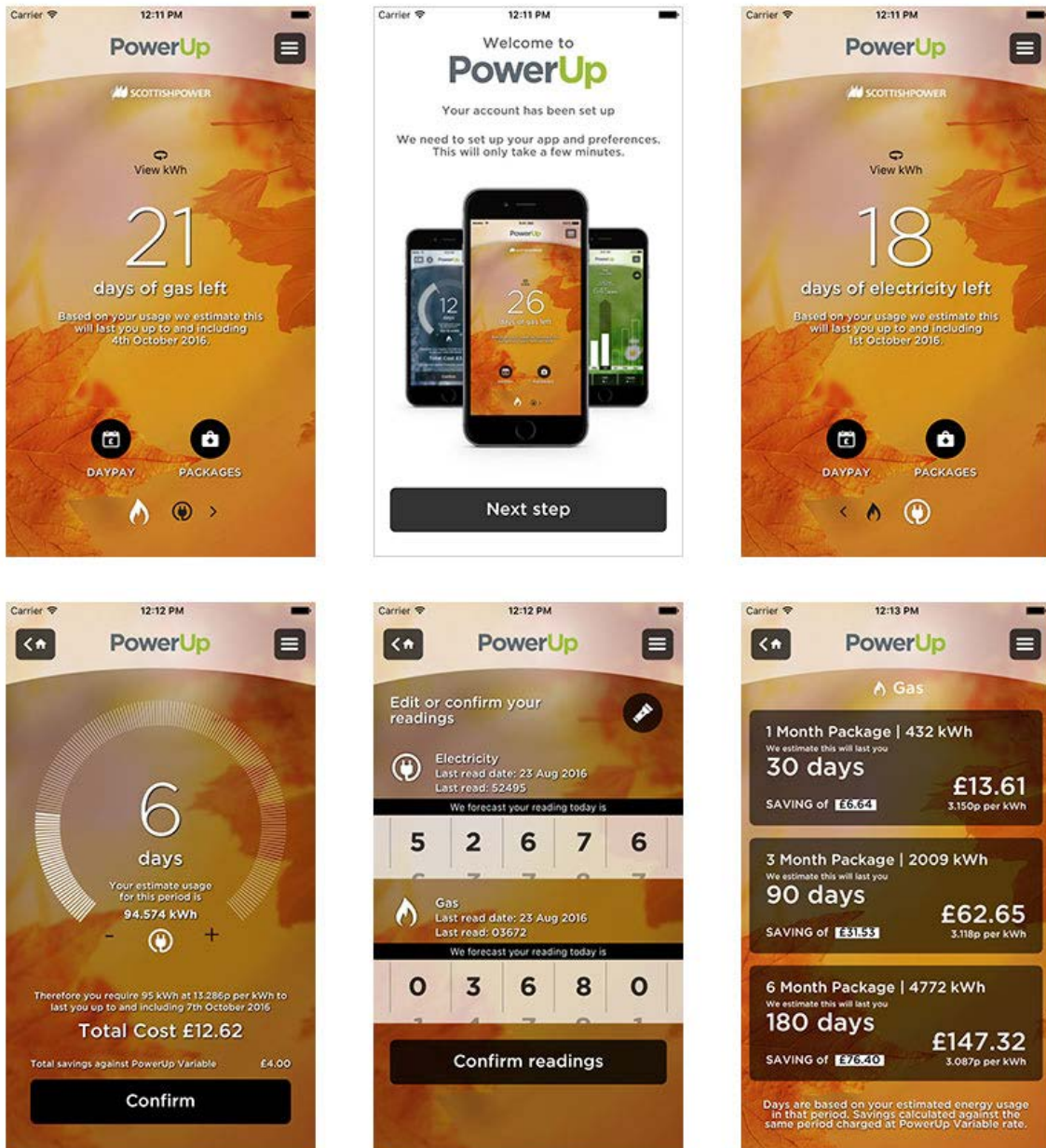

- In Spain, a new product has been launched: the **Energy Wallet**, which lets customers buy packages of 6, 12 or 24 months depending on their estimated energy usage. These packages are adapted to the consumption of each customer and the price is given upfront to help customers save on their bills.

Energy Wallet helps our customers understand what they are buying and avoids surprises when they receive their bill. Packages are bought for a set period of time and the price is given upfront. Customers can use the website to check how many days they have left on their package. Customers can choose to pay a fixed monthly amount or get a discount by paying for the whole package upfront.

Another innovative feature of this product is that the energy bought can be used wherever the customer chooses: whether in their primary residence or in a second home. The same package can even be used in multiple locations at the same time, with additional discounts. Naturally, all of the energy purchased using Energy Wallet is 100% green with certified guarantee of origin.



- Elektro Fácil: Iberdrola's Brazilian subsidiary, Neenergia, through its distributor Elektro, provides its customers with a mobile application that allows them to check their consumption, access invoices and manage their payments. The app includes other services such as reading the meter, programming an automatic shutdown or requesting a new connection.



Customised energy plans

At Iberdrola, we adapt our energy offerings to our customers' usage habits, helping them consume less energy and giving them advice on all aspects of the service:

Customised plans

Innovative offers tailored to each customer

Iberdrola advises customers regarding the Customised Plan that best adapts to their consumption so that they can pay less in the hours where they consume more. To do so, Iberdrola analyses the hourly consumption of millions of customers to propose the plan that fit their consumption. We always aim to offer each customer the most advantageous tariff for their electricity bill. In addition, after a few months the customer is confirmed whether the plan chosen is the best alternative or whether it is preferable to choose another plan to save more (In this case, the savings are quantified). In September 2015, Iberdrola launched its "Customised Plans". Available to over 12 million customers, these innovative plans are tailored to each customer's lifestyle, allowing them to make savings at peak times.

The main customised plans we have launched so far are:

- Stable Plan, for customers without large concentrations of consumption certain times of the day.
- Night Plan, for customers with heavy consumption at night and in the morning (October to March from 10 pm to 12 pm and March to October from 11 pm to 1 pm).
- Summer Plan, for customers with a summer residence where they use most electricity between 15 June and 15 September.
- Winter Plan, for customers with a second winter residence where they use most electricity between 1 December and 1 March.
- Weekend Plan, for customers with with a second home for weekends or who are not at home during the week and use most electricity on Saturdays and Sundays.
- Choose 8 Hours Plan, for customers who concentrate their consumption at certain times of the day and can choose at which times they want to pay less.



At the end of 2017 we made significant improvements to the Choose 8 Hours Plan, benefiting new customers as well as the more than 100,000 customers who already enjoyed the plan. These improvements were largely the result of the requests sent to us by our customers through surveys, focus groups, etc:

- › No more limits: from now on, customers can distribute their daily 8 hours however they wish (previously, they were restricted to 2 blocks of 4 hours or one block of 8, and they had to be the same hours each day).
 - › Real-time changes: customers can change their set hours in real time, whether in My Customer Area, through the Iberdrola Customer app, by phone or at a customer service point.
- Business Plan, for businesses that open every day of the year in the morning and in the afternoon.
- Horeca Plan, for hotel, restaurant and catering establishments which consume most electricity from 12 pm to 4 pm and from 8 pm to 12 am.

More than 800,000 customers now have Customised Plans, saving an average of 12% on their electricity bills. These customers also get the following services:

- 100% renewable energy with certified Guarantee of Origin.
- Continuous advisory service. Monitoring and energy saving advice, offering customers advice at all times on whether they should stay with their subscribed plan or switch to another plan for bigger savings.
- Flexibility; allowing customers to switch plans, without penalty, if they change their consumption habits and needs.
- Digital communication and subscription, with all the benefits of E-Billing.
- Customised offers using information from smart meters. Customers no longer have to change their consumption habits to make savings. Rather, they can take advantage of existing offers tailored to their consumption habits and can thus save even more.
- One Click sign-up, with this new service, current and future customers can sign up to contracts quickly and easily while getting the advice they need to choose the plan which is best for them.

The One Click service offers customers:

- A simplified sign-up process by reducing the amount of paperwork and information necessary.
- Plans that are customised to the customer's actual consumption; all the customer needs to provide is their address or a photo of their bill.
- An estimate of the Fixed Rate amount to be paid each month.

My Customer Area

In 2016, Iberdrola launched a redesigned My Customer Area with an enhanced user experience based on studies undertaken with customers. New features are constantly being added to respond to customers' needs.

The functionalities now available to customers with remote management are:

- Graphs showing their energy consumption, with different views available (yearly, monthly, weekly, daily and hourly) and a format designed to provide a better customer experience.
- Option to compare different date ranges to see how their consumption has changed over various periods.
- Estimation of the date and amount of the next bill.
- Tips on energy savings and efficiency
- Ability to export the information to various formats.
- Access to a monthly report summarising monthly consumption.

These features will soon be available in the customer app as well. New features will soon be added to those already available, as they are developed.

Public website (www.iberdrola.es)

The website has been fully redesigned, becoming much more visual with simplified, transparent content which is intuitive and easy to understand. The aim is to improve the process of signing up online. The procedure has been simplified as much as possible and now enables the customer to sign up for the Customised Plan that best suits their usage quickly and simply. In addition, whether or not they are existing customers, both individuals and businesses are given comprehensive information on all aspects which could help them save money on their bill: choosing the best package, optimising usage, tips on energy savings and efficiency, callback service to answer any questions, and omnichannel advice (web, telephone and in-person).

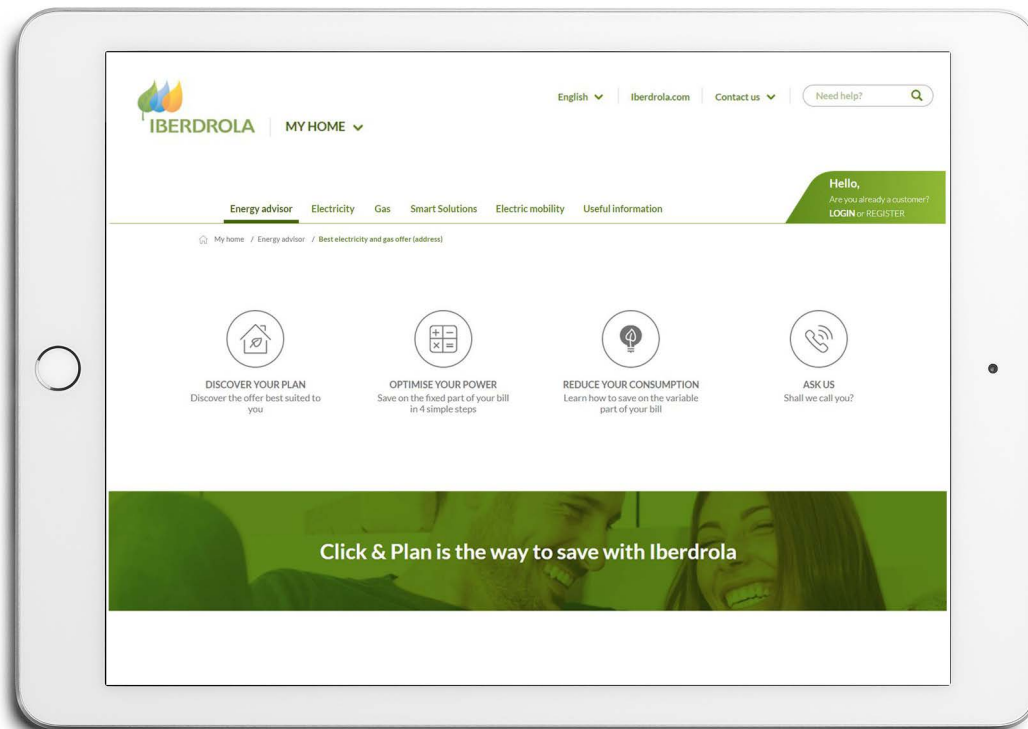

Customer App

New global experience area for residential customers

The behaviour of customers and users has changed, giving priority to everything *mobile* (via web and especially via the app). They also look for simplicity, transparency and modernity in the design.

This is why Iberdrola is committed to creating a unique *mobile* experience which allows users to carry out all operations from any device, especially *smartphones*.

After recently launching a private customer area and a public website (www.iberdrola.es) with a user-focused approach, attractive visual design and intuitive browsing, through the CLIENHUB project, we now intend to improve the app even further to ensure that all Smart Solutions (Smart Home, Smart Mobility, Smart Solar, Smart Services and Smart Plans) are simple and intuitive and offer an excellent user experience.

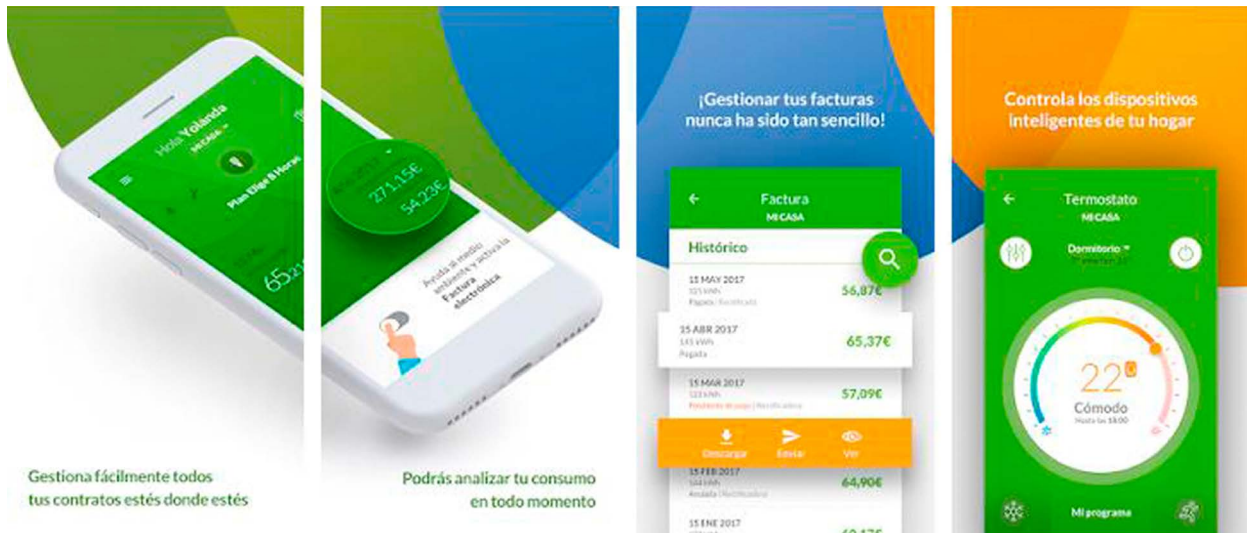

Gestiona fácilmente todos tus contratos estés donde estés

Podrás analizar tu consumo en todo momento

NYSEG Smart

An online space created by Iberdrola's North American subsidiary AVANGRID where customers can securely search for, compare and buy energy-efficient products, register for services and enjoy instant discounts, thereby saving money and energy and at the same time reducing their community's carbon footprint.

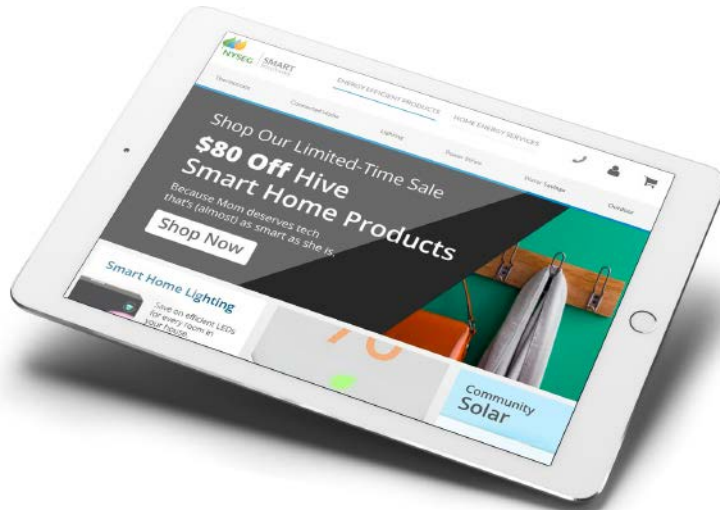

Smart and sustainable cities

By 2050, 70% of the world population will live in cities, representing 75% of global energy consumption and 80% of greenhouse gas emissions. According to the OECD, economic and demographic growth will have an unprecedented social and environmental impact.

As a company committed to sustainable development, Iberdrola is designing new technologies to bring renewable energies into urban areas, reduce pollution and improve air quality.

In this regard, we have implemented the Iberdrola **Sustainable Mobility Plan**, which involves employees, business activity, customers and suppliers. The programme is built around 23 specific actions with the following aims:

- Reduction of emissions.
- Promotion of energy efficiency.
- Improving the quality of life of the people in areas where the group operates.
- Creating a committed workforce.

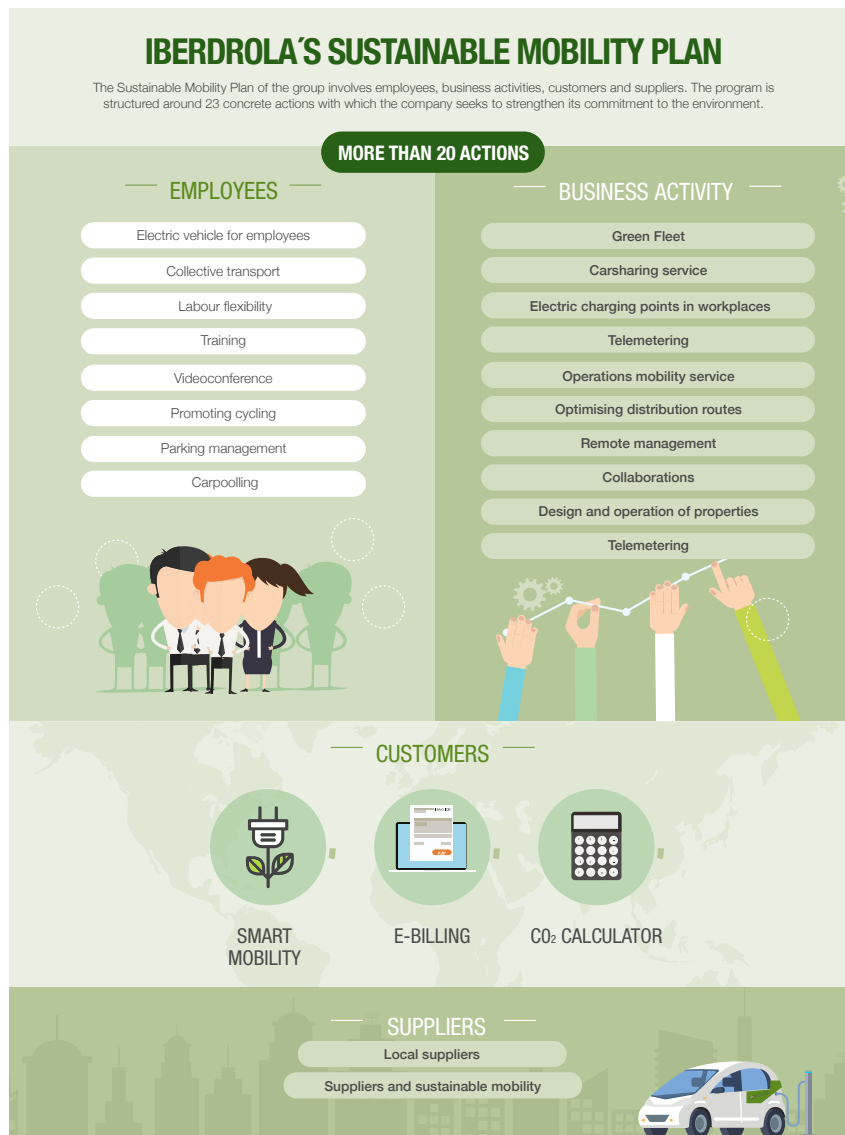

Some of these actions are described below:

- **Employee initiatives:** One of the initiatives Iberdrola has implemented is the Electric Vehicle programme for employees, launched in Spain, the UK and the US, which is expected to be implemented worldwide.

2016-2018: 273 electric vehicles divided into:

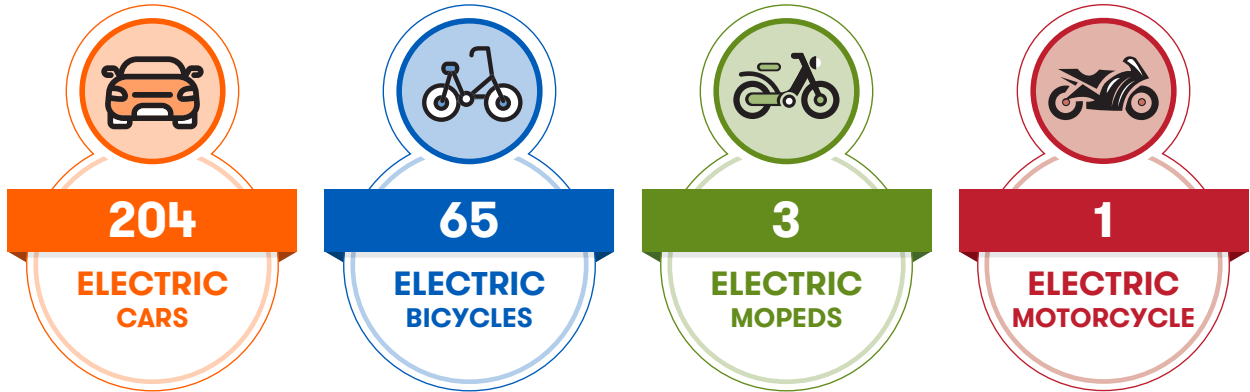

- **Business activity initiatives:** Employees have access to environmentally-friendly vehicles for commercial operations in Madrid, Bilbao, Valencia and Barcelona. On an international level, Avangrid, Iberdrola’s North American subsidiary, has announced a 2 million dollars grant that will enable the state of Connecticut to continue offering a popular discount programme for emissions-free vehicles. Avangrid has also implemented a subsidy programme through its subsidiary Central Maine Power (CMP).
- **Customer and supplier initiatives:** Iberdrola offers customers in Spain the Green Mobility Plan, an comprehensive mobility solution with zero emissions which combines an electric vehicle with a charging point and 100% certified renewable energy (for more info, see “Innovation in products and services”). Furthermore, as part of our commitment to creating value in the regions where we operate, we also promote electric mobility among our local suppliers by including a new parameter in our supplier database which identifies suppliers that have a sustainable urban mobility plan.

Iberdrola promotes today the mobility of the future



Choose your charging point

We take charge of it all:
We’ll send a technician
the installation
We offer a 2 years warranty



Save with the electric Vehicle Plan

An electricity plan with
0 emissions of CO₂
10 times cheaper than fuel
100 Km for 50 cents*



Take control from your home

Control everything from you mobile
with the Smart Mobility Hogar App

*0.03€/kWh 01:00 to 04:00 signing up for the Electric Vehicle Plan.
Estimated consumption of 0.16kWh/km.



The Sustainable Mobility Plan **has received multiple awards**, including a recognition received at the **V Awards for Best Practices in Sustainable Mobility presented by Renault** on 20 June 2017, **first place in the SMART MOBILITY category at the 2016 enerTIC Awards**, and the gold medal at the Spanish Sustainable Mobility Week Awards (SEMS 2016) organised by the Ministry of Agriculture and Fisheries, Food and the Environment.



In the UK, ScottishPower has launched a new product for electric vehicle owners. Customers can get **the UK's smallest charging point**, with full connectivity and impressive additional features, through the ScottishPower app:

- The ScottishPower app gives customers fully integrated control of their charging point.
- The advanced features include charge scheduling and remote blocking/unblocking, which will allow us to offer “time-of-use” energy tariffs in the near future.
- Customers can see the exact cost of each charge based on their ScottishPower tariff.
- They will also be able to get a discount on our new Electric Vehicle tariff, which uses 100% renewable electricity.



In addition, ScottishPower has come to an agreement with the UK's main car retailer, Arnold Clark, to let customers buy or rent an electric vehicle of their choice, arrange for the installation of a charging point at their home and sign up to an exclusive 100% renewable electricity tariff.

Iberdrola is also committed to the electrification of the economy, specifically in high-consumption sectors like air conditioning. We are thus **offering customers effective zero-emissions solutions: heating, air conditioning, heat pumps, electric heating and hot water storage.**





R&D Projects

R&D+i in the Generation area

The R&D+i efforts in the Generation area seek to secure new developments that can drive the efficient running of our assets in operation, new technologies for improving safety and the reduction of the environmental impact from this operation.

Projects undertaken in the **Operational Excellence** area are aimed at continually optimising operations and the consumption of resources, improving the performance, efficiency and flexibility of equipment and installations and managing their lifecycle. There are also initiatives aimed at developing new predictive maintenance techniques to minimise operational and maintenance costs and reduce environmental impacts. All these actions allow Iberdrola to adapt to an increasingly demanding environment that drives us to improve, both a technological view and with regard to processes and operations.

In an ever-changing and increasingly competitive market, marked by the emergence of new technologies, **Global Energy Management** committed to digital transformation by favouring innovation, ongoing improvements and flexibility, aspiring to reach new efficiency levels and operational optimisation, as well as dynamically detecting and taking on board new business opportunities.

Iberdrola is also committed to reducing the environmental impact of its generation plants through the implementation of various projects in the field of **environmental technologies and emissions reduction** enable us to improve the recovery and management of the waste generated and to adapt the plants to increasingly restrictive environmental requirements, providing an alternative to high-cost commercially solutions.

————— 18,487 MW of installed capacity —————

MEXICO

5,840 MW Gas

UK

2,001 MW Gas

BRAZIL

533 MW Gas

SPAIN

874 MW Coal
6,062 MW Gas
3,177 MW Nuclear

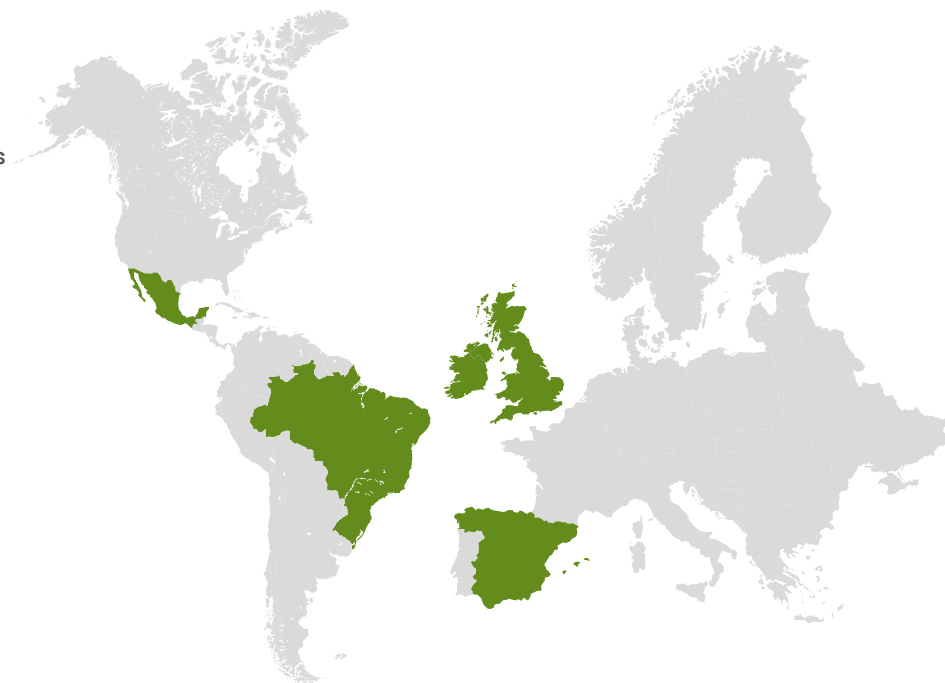

Operational Excellence

N23PURINUC

New developments in the condensate purification process

The refrigeration system is one of the most important systems in a nuclear plant, as well as being the main safety system due to its importance in keeping the integrity of the core. In BWR plants, the cooling water interacts with the reactor in the primary loop, and due to the risk of particle entrainment, it is necessary to then perform a demineralisation treatment to avoid possible radioactive contamination.

The overall objective of this project is therefore to research and develop a new safer and more efficient automated demineralisation technology to increase production capacity and eliminate the concentration of Fe in the feedwater associated with processes in the condensate area.

To this end, research has been carried out into new solutions and material compositions for resins aimed at achieving greater particle reduction efficiency, as well as achieving a reduction in the Co-60/Zn ratio.

OCTAVE

Development and demonstration of advanced supervision and control strategies to improve flexibility and optimisation of combined cycle plants

The overall aim of the project is to research, develop and demonstrate new diagnosis and control technologies for the combustion process in combined cycle plants, designed to supervise and optimise the operating conditions of the turbo-generator set. Implementing these technologies will allow greater flexibility in operating and maintenance conditions with respect to design specifications at different levels: reducing the technical minimum, minimising emissions and dynamics and allowing smart predictive maintenance. All this is based on advanced analysis of operating data, whether in real time or with periodic feedback, depending on the case, aimed at operational optimisation based on the actual conditions in the plant.

The following specific objectives have been established:

- Develop advanced techniques for permanent monitoring of the combustion status and tools to predict the behaviour of emissions and dynamics in order to optimise operating conditions and improve the flexibility of the plant (in particular, reduction of the technical minimum).
- Reduce the technical minimum of a combined cycle plant below the design value by setting an objective to reduce the nominal load up to 35%, maintaining flame stability while ensuring low emissions.
- Develop procedures for continuous supervision of the status of the plant to detect behavioural anomalies and optimise maintenance operations (in particular those related to the combustion process or combustion hardware).
- Integrate the combustion supervision and control module into a global model for process evaluation and identification of optimal plant operating parameters based on working conditions (energy demand, environmental conditions, fuel, plant hardware conditions) and operational restrictions (e.g. emissions limits).
- Demonstrate the system in a combined cycle plant, including the evaluation of results and options and procedures to adapt the technology developed in this project to other plants.
- Incorporate specific knowledge on technology to improve operational flexibility in combustion plants in order to lead or participate in the needs of the market.

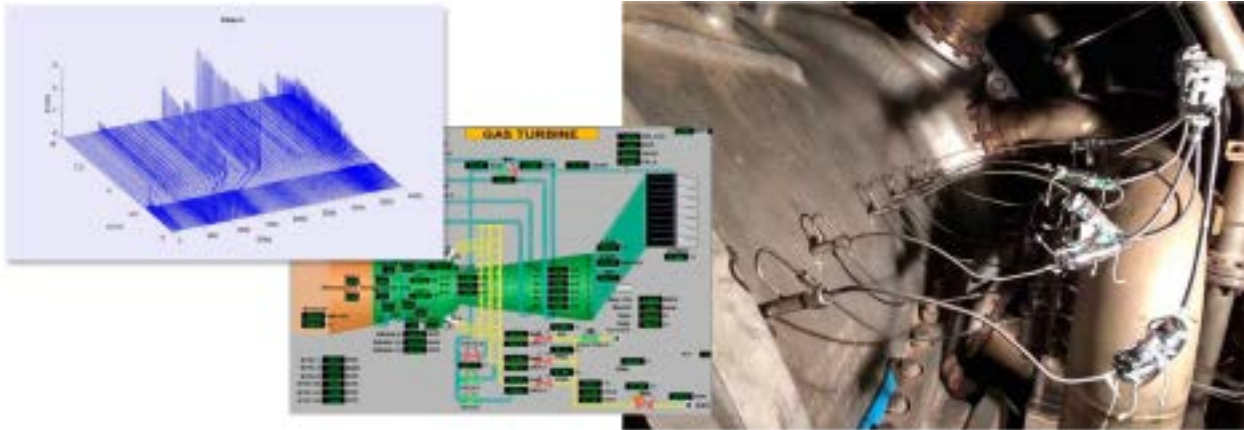

OFF-GAS

Continuous OFF-GAS monitoring

The aim of this project, completed in 2018, was the research and development of a new *Off-Gas* monitoring system for BWR (*Boiling Water Reactor*) nuclear power plants to monitor the integrity of the reactor fuel and control rods by continuously measuring gases, retrieving data in real time to increase the response capacity in case of detecting a fault caused by a control rod or fuel leak.

Some of the more prominent objectives of the project included:

- Continuous monitoring of the concentration of helium in the gas flow circulating in the *Off-Gas* line with a view to assessing the integrity of the control rods from the data obtained.
- Ascertaining the integrity status of the reactor fuel and control rods at all times, and thus improving their operations management process so as to ultimately minimise the degradation of the cladding.
- Continuously acquire the gamma spectra in the *Off-Gas* line with a monitoring time that could be modified according to the specific activity of the sample, including spectrum processing and calculation routines necessary for securing the specific activity of relevant noble gases present in the line.
- Increase knowledge on the operating status of the plant at all times through the incorporation of variables from the new *Off-Gas* monitoring system in the plant process computer.
- Reducing the time necessary for conducting the power suppression (*Flux Tilt*) tests, reducing plant downtime, dedication of laboratory personnel and their exposure.
- Increasing feasibility and availability by ascertaining the operating status of the plant at all times, which will enable the immediate engagement of protective measures upon detecting anomalies.



SIMUNEU

New technology to simulate neutron flux in BWR nuclear plant reactors

The aim of the SIMUNEU project, which was completed in 2018, was to develop new simulation tools based on the development and implementation of innovative plant models and calculation codes to acquire in-depth knowledge of the behaviour of components in the reactor of a BWR-type nuclear plant, both under stationary and transient operating conditions.

Achieving this general objective also led to the following specific goals:

- Development of new capacities that increase understanding of the phenomena that occur during transients, thereby improving plant safety and increasing operation margins.
- Increased precision in determining licensing margins for new models, in order to meet fuel design criteria and success criteria in specific accident situations.
- Maximisation of the operational flexibility of plants, with bigger operating domains or capacities.
- Optimisation of fuel management, maximising combustion, which will reduce the number of fresh fuel elements and high-activity fuel residues resulting from spent fuel.

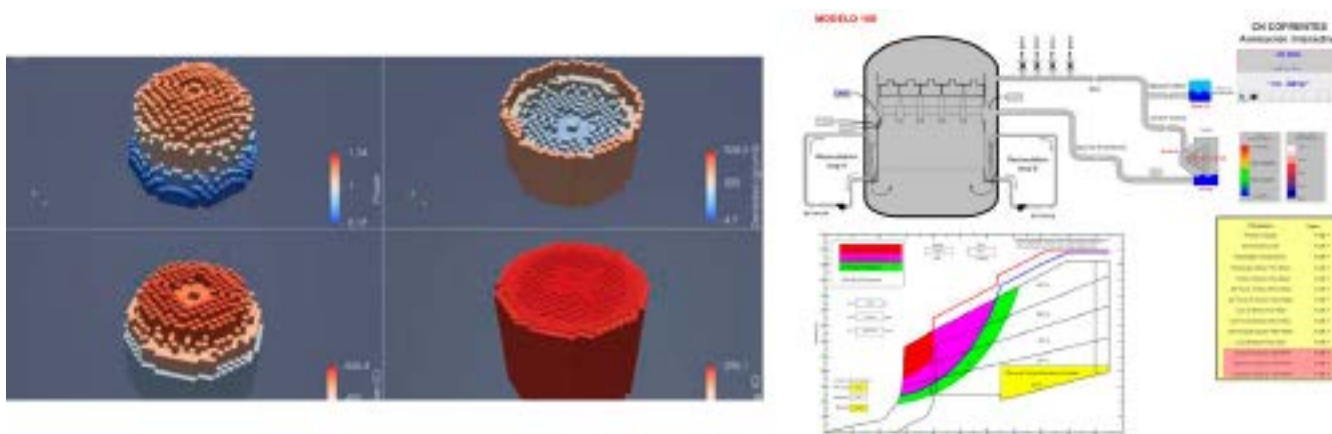

VESSELFLUE

New technology to calculate neutron flow to extend the useful life of vessel internals

As part of this project, a methodology has been developed to calculate neutron flow in BWR reactors and detects dispersion phenomena. This methodology provides to new tools to extend the operational time of the reactor, always guaranteeing the safety and efficiency of the plant in all of its operational ranges due to substantially more precise control over neutron flow.

To achieve the main objective, it was necessary to meet the following specific objectives:

- Increase the precision of the neutron fluence calculation by determining dosimetric uncertainty and the bias in the calculation of the new method.
- Forecast the best estimation of the neutron fluence of the pressure vessel based on analysing operational history, making the method predicable and robust enough to increase the licensing of the plant to up to 60 years.
- Contribute to the flexibility of operations in plants under maximum safety conditions, with bigger operating domains and capacities, due to the control of fluence in its different operating ranges.

ITSASERAUPEN

Offshore structure corrosion and macrofouling prevention

The ITSASERAUPEN project is an R&D initiative aimed at reducing the effects of seawater corrosion at generation facilities. This initiative arose from the need to alleviate the technical and economic issues that certain electrical facilities are facing because of seawater, namely offshore wind farms and generation plants that utilise seawater in their cooling systems.

The final goal was to develop a series of high-performance and environmentally sound primers that can meet the working conditions found in marine environments, where wear from highly aggressive corrosion occurs the most. These developments have produced a range of ceramic, polymer and hybrid (sol-gel) coatings with high resistance to fouling and corrosion, as well as processes to apply them to elements such as heat exchangers/condensers, tubes, pipes and valves.

To achieve this, some of the generation plant elements exposed to these phenomena, such as pipes, valves and heat exchangers, have been developed and tested with a new design, applying materials coated with corrosion protection materials of various types.

These new elements have been integrated into a seawater cooling system demonstrator, and a full analysis has been carried out of its performance compared to conventional materials.

Additionally, the equipment, systems and components in generation plants currently facing corrosion issues have been identified and the best solutions applicable for each case have been categorised.

All developments encompassed in the ITSASERAUPEN project have been carried out in terms of a full Life Cycle Analysis (LCA) and Life Cycle Cost Analysis (LCCA) conducted on the solutions to generate, including base materials, manufacturing processes, application and even integration at the offshore plants.



VIDAGEN

Development of an Inspections Management System and Structural Integrity Analysis in Thermal Plants

The aim of this project was to develop a tool to allow the global coordination of the lifecycle management of the pressure equipment in all of the Iberdrola Group's thermal plants (in Spain, Mexico, the UK and Brazil) in accordance with Iberdrola's own general criteria, that includes, in each case, the regulatory requirements of each country.

The tool also serves as the basis for the development of a structural analysis process as it contains a calculation module based on design codes and fitness for service.

It takes the form of a navigable 3D model of all of the plant's pressure equipment. This model gives access to all available information on these components: manufacture, assembly, operation, repairs, etc. Additionally, the system allows the necessary inspection scopes to be defined using a specific module which contains the legal inspection requirements as well as the Iberdrola standard requirements. Finally, an external access gateway has been created to allow NDT contractors to enter the results into the system directly.

The main project milestones were:

- Analysis of the various national regulations applicable to pressure equipment in the plants of Iberdrola Group.
- Analysis of the typical inspection scopes in each region.
- Definition of a casing, adapted to local requirements, which allows pressure equipment to be managed uniformly.
- Drawing up a Technical Specification with the requirements which the inspection management and calculation tool must have.
- Commissioning a pilot project to be carried out using the available information at CC Castellón 4.
- Evaluation of the results and assessing whether they met the requirements and needs.
- Launch of the Global Project.

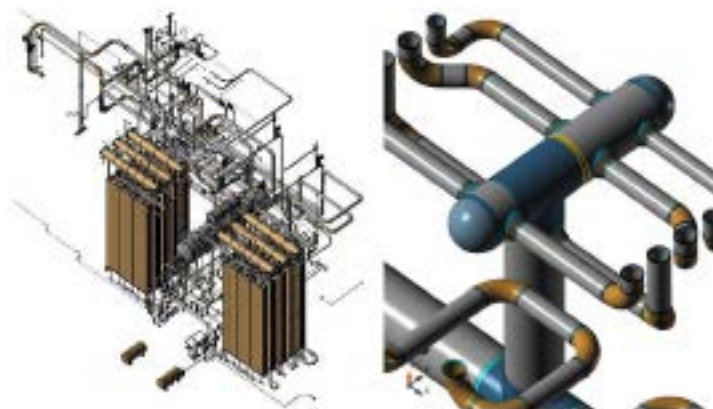

Efficiency actions in cogeneration plants

This project led to several actions being implemented in the Villarrobledo and Cartagena EW generation plants to increase the efficiency of heat exchange operations and reduce the caloric intake of the backup boilers. The following lines of action have been developed:

- Replacing the original water-tube recovery boilers in engines three and four with a new boiler with economiser in the Villarrobledo EW plant. This will allow steam production to increase from 3t/h to 4t/h in each engine, reducing the contribution of the back-up boilers by the same amount. Each of these actions could save up to 6.5 GWh/year of primary energy.
- Cleaning and renovation of the industrial back-up boilers at the Cartagena EW cogeneration plant, reducing the smoke temperature by approximately 35 °C, thereby improving their efficiency. This could save up to 3.6 GWh/year of primary energy.

COGEN 4.0.

The project has allowed the development of a predictive maintenance tool based on the online monitoring of the synthetic and mineral oil status of several critical systems at the Aranda EW plant:

- Oleo-hydraulic to start/launch the TG (mineral oil)
- Lubrication circuit of the Gas Generator systems (synthetic oil)
- Lubrication circuit of the gearbox and alternator of the TG (mineral oil)

To this end, several sensors have been installed to measure particles through image processing techniques using AI, and an algorithm has been developed which will generate exception alarms/events for subsequent processing, allowing a notable anticipation of equipment failure. Also included in the scope of the project is the accessibility of all of this information in real time from P&I.

In the case of aero-derived turbines it is particularly interesting to anticipate the premature failure of the starter in order to minimize plant unavailability, as well as significantly reduce the high consumption of synthetic oil generated by the breakdown when treated as corrective maintenance.



FILTRABRIS

New system to aspirate and filter debris in fuel channels in nuclear plants

This project, developed in collaboration with **GDES T4S**, is **aimed at designing and developing a debris aspiration and filtration system for fuel channels** to allow later analysis. This will increase knowledge of how debris forms and enters into fuel pools and channels.

With this project, Iberdrola has managed **to increase nuclear plant availability and operability by minimising the frequency of operation and maintenance works and the associated costs**, as well as increasing the reliability and durability of critical components, thereby making them safer.

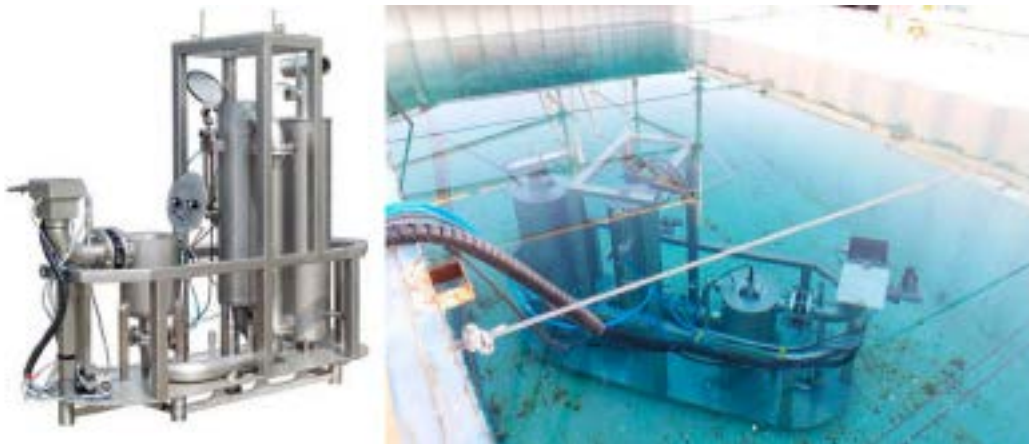

RESHAND

System to inspect and recover foreign material in nuclear containment pools

The RESHAND project, a collaboration between Iberdrola and GDES T4S, **has resulted in the development of a new system to inspect and recover foreign objects in containment pools**. The new system is a robust, autonomous and easily manipulable tool to increase the precision and efficiency of these kinds of operations, **reducing the associated risks and the human and financial resources needed**.

This tool allows Iberdrola to **guarantee the proper functioning of its nuclear plants and gives the sector new tools to efficiently manage health and safety in operating plants**, which will also help determine **prevention measures** in plant operations.



Boiler inspection

Creation of National Boiler Inspection Teams

This Neoenergia project is aimed at creating a team to inspect boiler tubes. This system will allow the display and recording of the trajectory, the measurement of thickness, and the transmission of data, taking into account the severe operating conditions (high temperatures, etc.).

The innovation in this project is found in two aspects of the system for displaying and recording images by industrial videoscapy: the automation of the system, which will allow it to be applied in areas with restricted access, and its application in harsher environments, with temperatures above 150 °C and in the presence of steam. The product generated will be a semi-flexible system capable of meeting access demands, climbing through pipes and operating independently whether or not it is in contact with water.

Energy Management and Energy Markets

REMIT

Operational transparency in markets

The REMIT project seeks to develop advanced tools for guaranteeing transparency in trading operations via three basic components:

- **Framework to prevent the use of privileged information.** A framework of internal procedures has been established, as well as a tool to monitor the entire process, from the occurrence of a significant event which could be considered to be privileged information until it is published on the Iberdrola website.
- **Surveillance to forestall market manipulation.** Work was carried out on three facets:
 - Related internal procedures.
 - Surveillance in continuous forward markets.
 - Surveillance in other markets (spot markets).
- **Operational reporting.** A reporting system has been developed which is capable of extracting relevant information from contract databases, transforming it and adapting it to the format specified by the regulator.



TRADE SURVEILLANCE

Surveillance of operations in wholesale energy markets

Iberdrola launched this project to improve its capacity to effectively monitor trading activity in Spain, the UK and the US, with the aim of reviewing our supply processes and implementing best regulatory practices in the area of market surveillance. The ultimate aim is to develop a solution to supervise our activity in the wholesale markets we participate in, composed of:

- **Surveillance system** which evaluates the supplies and operations conducted in different markets using a set of predefined rules and algorithms and provides automated alerts. The surveillance system is made up of two modules, one for continuous markets and another for call markets, taking the particularities of each market into account.
- **Case management system** to analyse and manage alerts and store the relevant documentation.

The project is expected to be fully implemented in the first half of 2019.



REMOTE CONTROL SYSTEM

Updated Remote Control System

The Remote Control System is the heart of the Central Operations Office, acting as the hub of our generation fleet in Spain. New technical and cybersecurity requirements, as well as the evolution of the electricity generation sector, lead us to the need to renew the current Remote Control System.

The new solution being implemented will be **adaptable to future challenges**, flexible in the face of regulatory changes, simplify the integration of generated distribution and active demand management, in addition to a new advanced graphical interface to facilitate analysis and reporting. It will also meet all of Iberdrola's **cybersecurity** requirements as well as those of the Spanish Critical Infrastructure Protection Law.

DATA GOVERNANCE

Implementation of Data Governance and Business Intelligence tool

Data Governance is a set of global processes to ensure that the data within an organisation is correctly managed. Its implementation involves moving from an operational environment to a **certified informational environment** using procedures, quality controls and information transformation tools.

Within this environment, we aim to implement a **Business Intelligence (BI)** tool to centralise standard reporting and streamline ad-hoc reporting and information analysis. The project has been structured into four phases:

- **Definition and design of the TO BE model.** Definition of data governance policies, definition of roles, generation of procedures, data dictionary proposals, design of architecture and specification of support software.
- **Implementation of procedures and creation of the base structure.** Implementation of procedures, preparation of required infrastructure, installation and setting up of management software (ETL, quality management systems), publication of dictionary templates, definition of validation rules and alarms, etc. During this phase, more than 200 indicators considered to be significant to GdEG were used (prices, yields, etc.).
- **Informational Software Development.** Once the previous phase of defining and implementing the base structure was complete, it was time to begin the phase of implementing the remaining informational databases until all of the necessary data and fields were included.
- **Iterative process of incorporating reports into the BI process.** Each report to be included in the BI process can be viewed as a mini project with several defined steps: Identification of concepts and sources, updating the dictionary, consolidating data, extending the model with new concepts, layout and publishing.

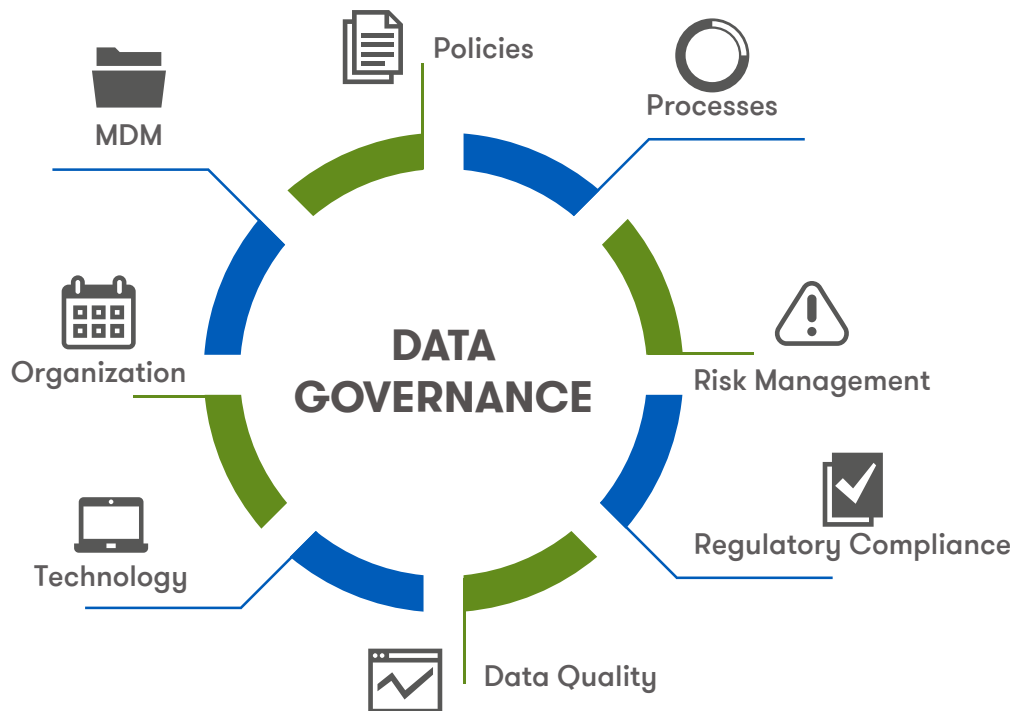

COBERTURA7

New tool for the automatic management of energy management coverages

The **overall objective** of the project was to develop a new **tool** to allow **centralised, automated management of commodity hedges and exchange rates** at a global level. This allowed the automatic calculation of sensitivities and the effectiveness test of the different hedges calculated for different market price scenarios.

The project, completed in 2018, included the following specific objectives:

- Obtain a **versatile and integrated final solution** which centralises the system and gives an overall view of all hedging transactions made.
- Improve support and **eliminate the dependency** on the know-how of multiple **analysts**, making it available to the whole company.
- **Automate the hedging transaction generation process** to **reduce manual intervention** by employees, eliminating human operational errors.
- **Increase productivity** among users of the new tool.
- Increase customer satisfaction due to much more accurate calculation of hedging transactions, leading to more favourable situations with regard to energy and gas prices.
- **Reduce** the company's **operating costs** by automating the process for calculating hedge transactions.

Electric vehicles

AZKARGA

Fast, efficient and smart EV charging stations

The principal objective of this project, completed in 2017, was to develop innovative solutions for fast, smart, flexible and manageable charging that fosters the widespread implementation of EVs.

To achieve this goal, the most advanced charging technologies used by electric vehicles currently on the market have been developed: advanced communications with both the vehicle and the backend systems of operators of this type of infrastructure, energy management capacities and different pricing and payment methods associated with charging, resulting in a set of state-of-the-art hardware and software elements.

More specifically, and in the framework of the AZKARGA project, Iberdrola has developed an app support the public recharging service, which will, to a large extent, be supported by this infrastructure. Not only will this app give access to Iberdrola's entire network of public charging points, it will also allow users to use their smartphones to book before arriving to guarantee the availability of equipment, unblock and access charging points by logging in through the app, and users will even be able to pay for these services using their bank card.

All of this has been undertaken using a simple and user-friendly interface that allows fast and convenient use of these recharging points for any electric vehicle user.



CIRVE

Iberian infrastructure corridors for electric vehicle rapid charging

The main objective of the CIRVE project is to promote the use of electric vehicles in Europe and ensure access to the Iberian peninsula. To achieve this, the project is developing a rapid charging structure with an international, multi-operator system to facilitate movement of these vehicles around the Iberian peninsula.

As part of this aim, the following specific objectives are being worked on:

- Increase the geographical coverage of rapid charging infrastructure in Spain, ensuring connection between the main cities along the Atlantic and Mediterranean corridors.
- Ensure national, cross-border (Portugal and France) and European interoperability.
- Develop guides for sustainable infrastructure growth while increasing the attractiveness of electromobility services for both operators and suppliers.

Specifically, as part of the CIRVE project, a network of 40 rapid charging points is being created, with Iberdrola leading its deployment.

REMOURBAN

REgeneration MOdel for accelerating the smart URBAN transformation.

The central aim of this project is to develop and validate a sustainable urban regeneration model to take advantage of the overlap between energy and the mobility and information and communication technologies sectors. The objective is therefore to accelerate the deployment of innovative, cheap and organisational technologies to significantly increase the efficiency of resources and energy, improve the sustainability of urban transport and drastically reduce greenhouse gas emissions in urban areas.

The project was launched in 2015 and, to ensure that its main objective is achieved, the following activities are scheduled:

- Developing a holistic model of sustainable urban regeneration that supports the decision-making of the main stakeholders to address the renovation and transformation of the city.
- Validating the urban regeneration model through large-scale interventions in various "lighthouse" cities, namely: Valladolid (Spain), Nottingham (UK) and Tepebasi/Eskisehir (Turkey).
- Guaranteeing the replicability of the model at European level. Two "follower" cities, Seraing and Miskolc, are also taking part in the consortium and will develop a procedure to evaluate the potential for repeating the model.

More specifically, Iberdrola is responsible for developing and operating a public charging network in Valladolid made up of 19 charging points of various speeds. Iberdrola is also developing the software tools necessary to integrate information on the use of this infrastructure into the project's global analysis models, thereby helping to reach the overall objective of the project: to develop an urban regeneration model that can be replicated in other cities. Furthermore, we are coordinating and leading the deployment of electric vehicle charging infrastructure in the other cities in the project.



Your electric vehicle

Electric Vehicles for Employees

Iberdrola has again launched the Electric Vehicles for Employees initiative as part of its Sustainable Mobility Plan so that employees can move in a sustainable manner. Launched in 2016 and updated in 2017 and again in 2018, it has been extended to the United Kingdom and the United States. The “Electric Vehicles for Employees” plan includes grants which are compatible with government financial grants:

- Iberdrola offers a special advance for the purchase of a “100% electric vehicle”.
- The company offers assistance to employees who contract a recharging point through Iberdrola.
- Non-refundable grant for advertising sponsorship for 100% electric cars, bicycles and electric scooters and motorbikes.

Thanks to this initiative, local emission of 244 tCO₂ was avoided when employees travel to the workplace in Spain and the United Kingdom.



Environmental Technologies and Emissions Reduction

The **Biodiversity Report 2014-2017** describes the company's initiatives to protect natural capital and biodiversity.

CO₂FORMARE- SPAIN

Use of CO₂ for macrofouling remediation

This project demonstrated that the CO₂ present in the combustion fumes generated by industrial processes near the sea can be used a substitute for the chlorinated chemicals employed at these facilities as a solution to operational and maintenance issues and to prevent biofouling in their refrigeration circuits.

The project took place at the Castellón combined cycle thermal power plant to check the ability of CO₂ to inhibit the phenomenon known as macrofouling (the process of the degradation of equipment, components or systems caused by the uncontrolled growth and attachment of large living organisms such as mussels, clams, etc.), a problem that causes substantial harmful effects to the facilities and their surroundings.

Meeting the objective of this project involved the following:

- Installing equipment that enables constant and autonomous monitoring of the larva content of species that cause macrofouling, generating numeric values indicating the concentration in the medium under study.
- Preventing water-borne incrustation organism attachment and development through a moderate decrease in cooling seawater pH by dosing the cooling seawater with CO₂.
- Capture and concentration of a sufficient amount of CO₂ from the plant's chimney for subsequent dilution.
- Dissolving the CO₂ gas in seawater and producing seawater currents with different CO₂ saturation values to be dosed into the seawater pumping chamber for cooling.
- Storing the CO₂ captured in the innovatively designed storage tank, which allows fluid to be stored under optimum conditions.
- Developing a successful communication plan to disseminate the results generated to strategic stakeholders both nationally and internationally.

The application of the technologies developed in this project has a double environmental benefit: firstly, it reduces the injection of chlorinated compounds into seawater and secondly, it prevents the emission of greenhouse gases into the surroundings, maintaining the plant in optimum operating condition and ensuring the continuity of supply and grid stability.



MIGRES

Development of a comprehensive method for managing control rods and channels as radioactive waste

This project involved the development of a new process for the integrated management of control rods and used fuel channels as radioactive waste in a BWR (Boiling Water Reactor) nuclear plant. This allows this waste to be managed sustainably, reducing the volume of waste stored, freeing up space for the storage of higher activity waste and minimising handling costs.

The following specific objectives have been met:

- Design of an integrated process that, by reducing waste volume, allows for its subsequent efficient and rapid management when it can be shipped to centralised storage.
- Scheduling cutting operations and conditioning to minimise the possibility of contaminating fuel pools with effluents from rods or cutting particles and waste.
- Reduction in opening and closing of gates between the different pool areas to minimise the possibility of faults or losses in the seals of these gates.

To achieve the proposed objectives, the project was undertaken in three stages:

- Initial research of the facility to establish the initial requirements: analysis of prior information and evaluation of nuclear waste profiling techniques.
- Design and development of the new technology to manage control rods and channels in BWR plants: this activity comprises the development of methods for radiologically profiling control rods and channels, and the cutting and conditioning of waste, in addition to the design and development of an experimental prototype.
- Development of technology tests and validation.

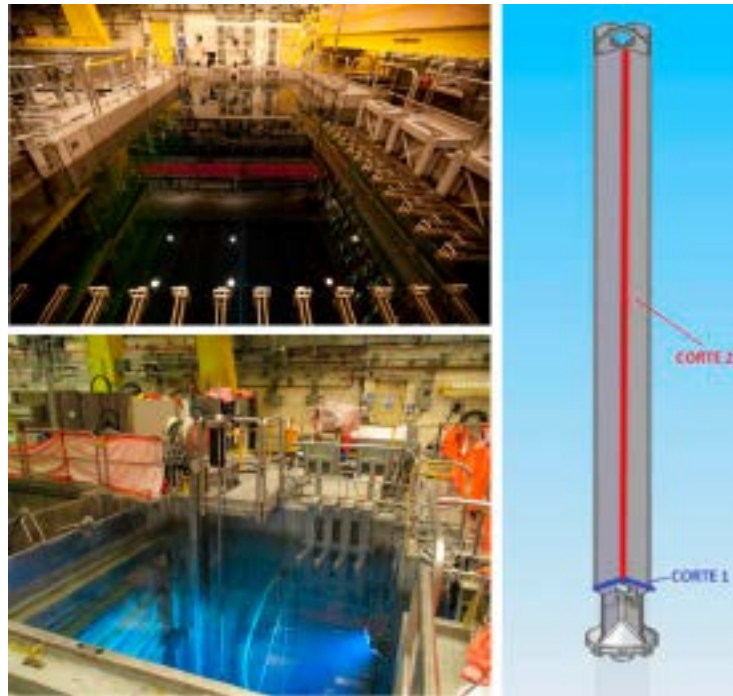

QUEMANOX

Design of a new ultra-low NO_x burner for thermal plants

During this project, ultra-low nitrogen oxide (NO_x) technologies were developed for combustion processes in conventional pulverised coal thermal plants, simultaneously with a flexible and optimised operation and the optimisation of the concentration of unburned residues in ashes, which allow the strict standards of European directives to be fully met.

The specific technical objectives of this project were:

- Achieve NO_x emissions levels below 350 mg/Nm³ through the exclusive use of primary measures in diverse scenarios with varying load levels, varying numbers of mills in service or active burners, etc.
- Neutralise the increase in the percentage of unburned residues in ashes associated with NO_x reduction measures, maintaining the baseline percentage.
- Obtain new designs and formulas for flexible boiler operation which guarantee its performance independently of the number of active burners.
- Provide the simplest possible strategies to implement new NO_x ultra reduction techniques in pulverised coal thermal plants, with minimum interference in existing facilities and making optimum use of their capacities, making it economically viable to replicate them in a high number of similar cases.
- Generate new knowledge in relation to the synergistic combination of different techniques based on primary NO_x reduction measures and their effect on the formation of other polluting substances and the generation of non-reusable waste.



REMINOX

New ultra-low NO_x emissions technologies in thermal plants

The general objective of the REMINOX was to achieve ultra-low (<200mg/Nm³) NO_x emissions in pulverised coal thermal plants by developing selective non-catalytic reduction (SNCR) technology based on optimising reactive injection strategies, achieving high reduction efficiencies in a wide range of load conditions and boiler operation scenarios.

The following specific technical objectives have been met:

- Achieve NO_x emissions levels below 200 mg/Nm³ by applying secondary non-catalytic measures in a scenario pre-optimised by means of primary measures in diverse situations with varying load levels.
- Provide new strategies to implement new NO_x ultra reduction techniques in pulverised coal thermal plants, with minimum interference in existing facilities and making optimum use of their capacities, making it economically viable to replicate them in a high number of similar cases.
- Generate new knowledge in relation to optimising reactive injection strategies in the boiler and the combined effect of secondary measures alongside with primary measures (e.g. air into fire) on the formation of NO_x and other contaminating substances and the generation of non-reusable waste.



Before and after adapting the desulphurisation building and installing equipment to inject urea into the boiler.

GRUCOMB

Development of a new spent fuel management tool

The main objective of the project was to develop the means necessary to handle spent fuel containers in pools, allowing heavier containers to be loaded and transported, resulting in more storage capacity. The aim is to minimise the number of containers required to store all the fuel, a big step forward in terms of managing resources and minimising the amount of waste generated.

More specifically, the technological objectives set during this project were:

- Design and develop a new lifting system to significantly increase the loading capacity of the gantry crane in the fuel building, giving it the characteristics necessary to manage heavier containers, based on the single failure criterion.
- Design and develop new reinforcements necessary for the crane to support the increased lifting weight.
- Improve container handling by using a safer and more reliable tool capable of improving spent fuel transport times with the associated dose reduction, as well as being able to guarantee the integrity of the load in the event of an earthquake.



EPESOL

New instrument to evaluate solar penetration in the Spanish energy market

The EPESOL project, which began in 2018, aims to develop a **tool to help evaluate and monitor the feasibility of a solar installation based on an accurate prediction of solar production.**

To achieve this, **predictive models** will be used to calculate **solar potential**. These models will include **geo-spatial variables** (vertical dimension, albedo), making the results **more precise**. The tool will represent **spatial information in three dimensions**, 3D GIS/SDI, and will allow **the establishment of hourly profiles of solar production capacity** for different types of users (domestic, tertiary sector and agricultural sector).

These profiles will be used not only as the basis for analysing the **feasibility of the installation** of photovoltaic panels on a case-by-case basis, but also for Iberdrola to design **customised solutions** for each user, including the most adequate solar capture technology, storage systems and tariffs based on consumption patterns.



Eco-Efficient Solutions for Biofouling

Development of eco-efficient solutions to control biofouling in the Termopernambuco cooling system

The aim of the project is to develop eco-efficient solutions to control incrustation of organisms in the cooling system of the Termopernambuco combined cycle thermal plant. The use of economically feasible and sustainable chemical, physical and biological methods will be studied to identify which ones are the most effective at inhibiting incrustation under local environmental conditions.

The project will study the extraction and chemical isolation of natural metabolites with anti-incrustation properties produced by some marine species to generate a composite based on silicone and natural metabolites to prevent organisms from attaching when used within the cooling system.



R&D+i in the Networks Area

Renewable energy generation sources have been steadily increasing their participation in the generation mix in the developed countries. This reality translates into new challenges for the electricity distribution network, which was initially designed based on the requirements of conventional energy sources.

The networks of the future must play a fundamental role in the energy transition by:

- Optimising the planning and development of the grid in response to the electrification of transport and thermal energy.
- Ensuring the operation of the electricity system with a high penetration of intermittent generation.
- Integrating Distributed Generation Resources (renewables, storage, EVs)
- Enabling active demand management and providing network adjustment services.

To achieve this, distribution systems are evolving toward **smart grids**, which combine traditional facilities with modern monitoring technologies and information and telecommunications systems. The smart grid includes new functionalities, giving greater visibility to what happens at each connection point (remote management, telemetry), increased automation (real-time operational assistance systems), cutting edge power plant protection systems and increased capacity to manage demand and production.

In recent years the European Union has invested around 3 billion euros in research projects into Smart Grids to enable the electricity network to incorporate more clean, renewable energy and encourage efficient, quality and responsible consumption. In this context, Iberdrola has continued increasing its efforts in R&D&i projects, especially in Smart Grids, in Spain and the rest of Europe. The group's R&D&i activities in electric power distribution focuses on **optimising the distribution network, particularly in the areas of occupational safety and the environment, and to improving the quality of the supply.**

At the same time, the Qatar Technology Center is working on several initiatives to develop and implement smart grids.

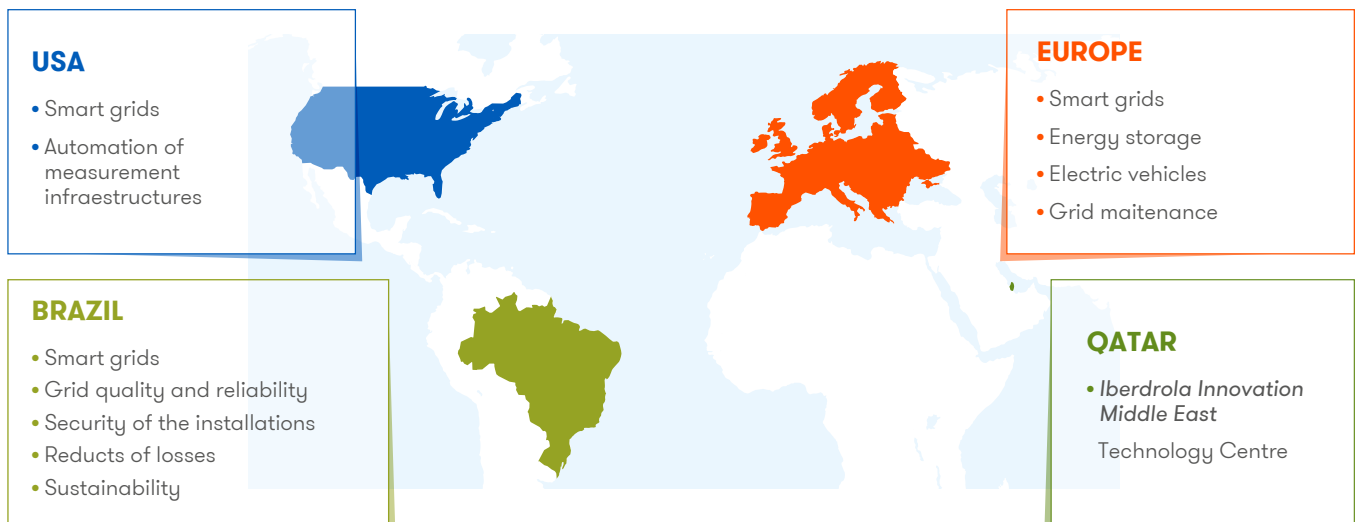

Smart grids

UPGRID

Real and tested solutions to enable the flexible integration of active demand management and distributed generation

Low-voltage (LV) and medium-voltage (MV) grids are currently afflicted from local accumulations of distributed generation, resulting in increased risks and difficulties in managing the distribution network. Similarly, the lack of observability and control means the LV grid cannot be operated and maintained under optimum conditions.

This project therefore proposes a standardised, open and across-the-board improvement to LV grids by developing four demonstration facilities running in a real smart distribution grid environment. These demo facilities are currently in the execution phase in the following European locations: Bilbao area, Spain (from the Bidelek Sareak showroom), Parque das Nações in Lisbon, Portugal; Åmål municipality in southern Sweden, and Gdynia in northern Poland.

The project is pursuing the following objectives:

- Developing and validating solutions to allow advanced functionalities to be added to existing technologies, thus setting up a truly integrated smart system.
- Improving observability and control capacity of LV and MV grids so as to better anticipate technical problems associated with the large-scale integration of distributed generation, while also bringing end consumption (LV and MV) closer to operating and planning systems.

This three-year project got under way in January 2015 under the European Horizon 2020 (H2020) programme developed by an Iberdrola-led consortium comprising nineteen partners from seven different European countries: Spain, Portugal, Sweden, Poland, the United Kingdom, France and Norway.

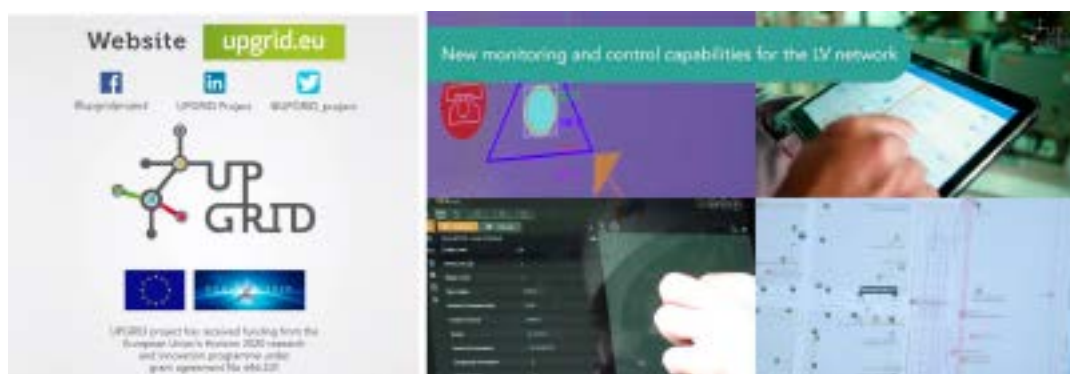

mGRIDSTORAGE

Advanced microgrid model with storage for distribution grids.

Iberdrola leads the mGRIDSTORAGE project, funded by the Basque Business Development Agency as part of the Hazitek programme, which has a duration of 2 years and is developed by a 12-member consortium with the collaboration of 9 agents from the Basque Science, Technology and Innovation Network.

The objective is to research and develop technologies to create an advanced microgrid connected to the distribution network, including everything from storage technologies to control and management technologies to generate a competitive and interoperable microgrid concept.

Iberdrola is mainly involved in:

- Conceptualising the microgrid: defining locations, pilot parametrisation, service analysis, simulation and dimensioning the storage and architecture of the management system.
- Controlling development, communications and safety.
- Operating concepts and business models.

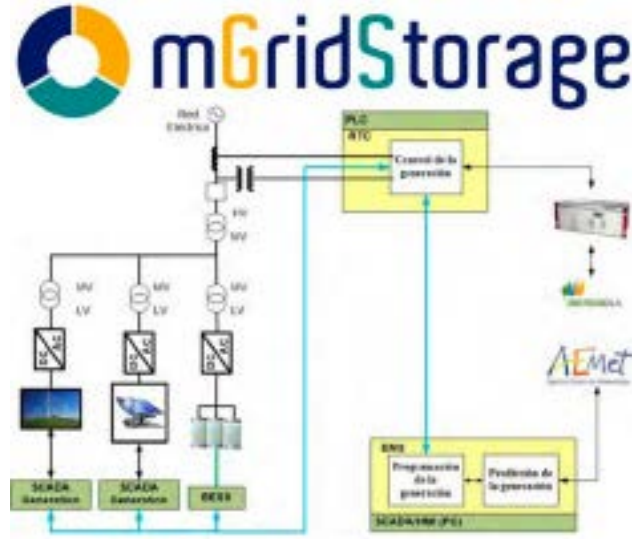

INTENSYS4EU

INTEgrated ENergy SYStem, a Pathway for Europe

The INTENSYS4EU project is being developed as part of the European H2020 programme and its overarching goals are two-fold:

- To support the further integration of innovative solutions in view of accommodating 45% variable renewables by 2030 while operating the energy system in a safe, stable and secure way.
- To extend the existing R&D&i roadmaps through permanent and direct interactions with the impacted energy system stakeholders and all the Member States in view of validating the portfolio of innovative solutions via appropriate funding mechanisms.

ASSURED

fASt and Smart charging solutions for full size URban hEavy Duty applications.

ASSURED has been funded by the European H2020 program and will develop various innovative solutions for heavy-duty (HD) and medium-duty (MD) vehicles with interoperable charging infrastructure concepts and solutions to be tested in several European cities.

The high-potential charging solutions will have powers of 300 kW to 600 kW and charging durations of <30 seconds, <5 minutes and 30-50 minutes.

Iberdrola's role will be to evaluate the interaction between the charging infrastructure and the electricity grid by studying the impact of different charging solutions on the distribution network to ensure their safety and reliability.

DISCERN

Improving the operation of distribution networks through optimal use of distributed intelligence.

The DISCERN project (Distributed Intelligence for Cost-Effective and Reliable Distribution Network Operation), part of the European H2020 programme, has evaluated the optimum level of intelligence to be installed on distribution grids so as to determine replicable technological solutions that will enable devel-

opment without comprising grid reliability, profitability and controllability. This has allowed for more rational grid management and better planning of grid scale and extension, thus facilitating the large-scale introduction of renewable distributed generation.

The project has provided recommendations for optimum levels of intelligence distributed across medium- and low-voltage grids. These recommendations have arisen from an analysis of five previous projects operated by five major European distributors, and also of field tests conducted during the project on a number of the recommended technologies implemented at three distribution networks.

The project was divided into three areas:

- Validation of the demonstration projects and creation of use cases: analysis and comparison of solutions by defining use cases common to all projects.
- Simulation and tests: simulations and roll-outs of the demonstration projects to validate the solutions and measure their performance through the use of key performance indicators (KPIs).

STAR+

The STAR project allowed Iberdrola to deploy more than 10.8 million smart meters in Spain, improving grid operations and the quality of supply we offer our customers.

The STAR+ project continues to digitalise the grid to improve efficiency and prepare the company for its role as a future distribution system operator (DSO). The principal objective is to maintain the “rhythm of change” to integrate future “flexible” customers with distributed energy resources (photovoltaic, active demand management, batteries, etc.) into the grid.

To do so, the following specific objectives have been defined:

- Digitisation of processes.
- Deployment of advanced low voltage (LV) supervision.
- Low voltage control system.
- “Non-regulatory” deployment of smart meters (300,000 supply points).
- Microgrid demonstration project at the Iberdrola Campus in San Agustín de Guadalix near Madrid.

The following results are expected to be achieved:

- Information on low voltage energy balance to reduce losses and improve the new supply connection process.
- Smart detection of incidents (fuses, overloads) and faults, using mobility tools to inform the brigades.
- Full deployment of smart meters in MV and HV grids to complete energy balances.
- Integration of batteries and renewable generation into the microgrid operations control system.

Bidelek 4.0

Iberdrola, together with the Basque Energy Agency (EVE) and the Diputacion Foral de Bizkaia, will continue to promote the digital transformation of the electricity distribution grid in Spain's Basque Country thanks to the **Bidelek 4.0 project**, which has a budget of 30 million euros over three years, ending in 2021.

The main strategic objectives of this initiative are:

- The efficient integration of auto-consumption and other distributed energy resources, providing new services to consumers/prosumers who are increasingly more informed and more aware of efficiency and sustainability.
- To show how distribution networks will enable the transition to clean and sustainable energy.
- Use the increased digitisation of electricity grids and the functionalities of new technology solutions to increase the quality of service and the added value of electricity for consumers.

- Begin the evolution of the electricity distributor toward its future role as Distribution System Operator.
- Maintain the Basque energy equipment industry's position of technological leadership.

More than 25 companies will participate in this innovative project, which will be a global technology reference point and promote the Basque Country's capital goods industry and energy infrastructures.

The solutions developed as part of Bidelek 4.0 will be used by Iberdrola to implement more and smarter grids as a way forward in the energy transition toward a decarbonised economy.

ALOIS

System for the control and protection of real medium voltage feeders for stable and sustainable island operation

The ALOIS project, which began in 2018, aims to develop a control and protection system using medium voltage feeders in electricity distribution grids to achieve stable and sustainable operation.

The specific objectives to be met in order to achieve the general objective are:

- Develop and validate, using simulation, primary and secondary controls and protection systems suitable for island operation.
- Determine the robustness of control and protection structures and systems in terms of penetration of distributed generation and feeder demand.
- Determine the stability margins in terms of penetration of distributed generation and feeder demand.

This will allow the following benefits to be obtained:

- Minimise impact during incidents, using generation to maintain voltage levels and prevent overloads.
- Reduce the number of customers affected during works or failures.
- Ensure a reliable supply in the event of contingencies.
- Keep generators connected to the grid.

Caravaca BESS project

Battery Energy Storage System

This project, which began in 2018, was created with the aim of integrating a battery energy storage system (BESS) to function as an alternative to reinforce the grid with photovoltaic generation in weak areas.

The following actions are currently underway:

- Install and operate a BESS to improve the quality of services in LV lines.
- Test out BESS to resolve real grid problems: voltage and incident control.
- Demonstrate improved efficiency in the integration of renewable energies.
- Resolve operational problems in island operation mode.

The results of the project will improve the quality of service in LV lines, standardise BESS as an alternative for grid backup and develop microgrid operation models and control systems for the integration of distributed generation.

Smart Grid Technology

Developing technology for the Smart Grids of the future

With this project, Neoenergia aims to develop the technology necessary to implement Smart Grids in the future:

- **Smart sensors with new functionalities**, longer useful life, less consumption, and operability up to a voltage level of 69 kV. These will allow network planning, asset administration, loss detection and fault location. Also, we will continue to improve **the smart transformer** developed in a previous R&D project for automatically recording measurements and identifying drops in conductors in low- and medium-voltage lines, and a **power quality measurement instrument** that will use an innovative technique to compress data, allowing continuous oscilloscope recording with automatic submission of data and improvement of service quality.
- **Development of a simulation** to allow communication networks and the electricity grid to be evaluated jointly, including aspects such as reliability and cost-benefit ratio. To do this, Advanced Distribution Automation (ADA) with an auto-repair function will be implemented, with the ability to take high impedance faults into account and identify the type of fault. Furthermore, an analysis platform will be implemented to study the large volume of information from corporate systems and the systems developed, and the connectors needed to integrate the systems involved into an interoperability bus.
- **Communication hubs, gateways and modems with cryptographic modules** will be developed to allow secure communication for devices which belong to Smart Grids (Meters, Smart Sensors, Smart Transformers, etc.) using the Wi-SUN protocol. The hub will provide transmission savings, reduce the risk of data being lost and integrate the products mentioned above.
- Installation and validation in the field of the devices developed, the **Advanced Automation of Distribution networks and Intelligent Metering**.



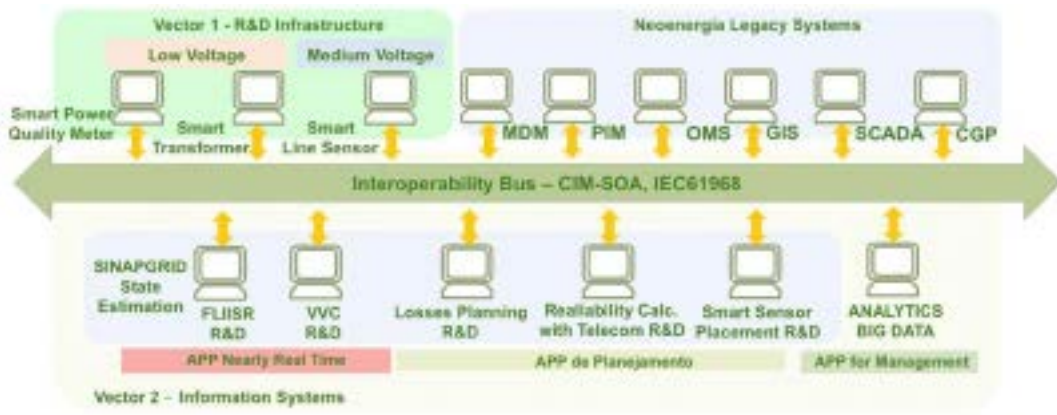

Interoperability Bus

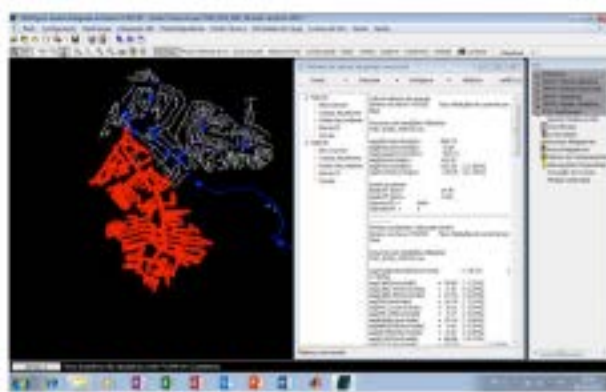

Electrical calculations platform

Smart Grids

Implementation of the concept of Smart Grids in pilot locations with severe environmental restrictions

This project, developed by Neoenergia, is aimed at implementing a model of smart grid on the island of Fernando de Noronha in Brazil using Neoenergia’s distribution grid as a test bed for this new technology. The project was finalised in 2017 with the installation and commissioning of advanced telecommunications, smart measurement and automation devices and micro-distributed generation structures. These actions have reduced disconnection times with grid auto-configuration, improved power supply quality, and remote control of consumption unit reading and reconnection processes. An electric charging station has also been installed to promote the use of electric vehicles.



Car electric charging station.



Micro-distributed generation



Efficient lighting

Bid Monitor

Big Data and Data Monitoring: Artificial intelligence to support decision-making in electricity auctions.

This project aims to develop a system capable of capturing and monitoring different sources of information to build a database with the biggest amount of information possible on the Brazilian electricity sector.

Using big data techniques, automatic learning and advanced statistical analysis, a set of tools was developed to monitor data in real time to follow the behaviour of data relevant to the participation of a small generator or distributor in electricity auctions.

The project is shared and aims to optimise the electricity buying process, which is known for being very complex.

Smart City

Smart City, a reference model for the implementation of smart grids

The aim of the project is to develop a reference model for smart grids applied to the implementation of smart cities, including innovative solutions for the automation and operation of the electricity grid, distributed generation, telemetry, electric vehicles and new services for consumers. The smart grid technology has been tested and implemented in the city of São Luiz do Paraitinga.

As a result, the main impacts on technical-operational processes and changes in consumer consumption habits will be evaluated. Thanks to the community participation and knowledge of the project is expected to achieve better levels relating to rational energy use and energy efficiency, allowing the city to be defined as a Smart City.



Smart City in São Luiz do Paraitinga

Meter evaluation

Evaluation of the safety of electronic and smart meters

This project addressed the structuring of two laboratories, one at CPqD and the other at Elektro, prepared with software and hardware for integrated software metrology tests and intrusion tests focused on cyber attacks. Also, prototypes were developed to simulate and reproduce the main information security vulnerabilities generally present in these energy meters.

By evaluating and testing the reliability of cybersecurity for application in electronic and smart meters, defining minimum security requirements for the systems integrated in these meters and creating the first Meter Safety Certification Laboratory, incremental improvements can be made to the process of selecting manufacturers and electronic meters for implementation in smart measurement in Brazil.

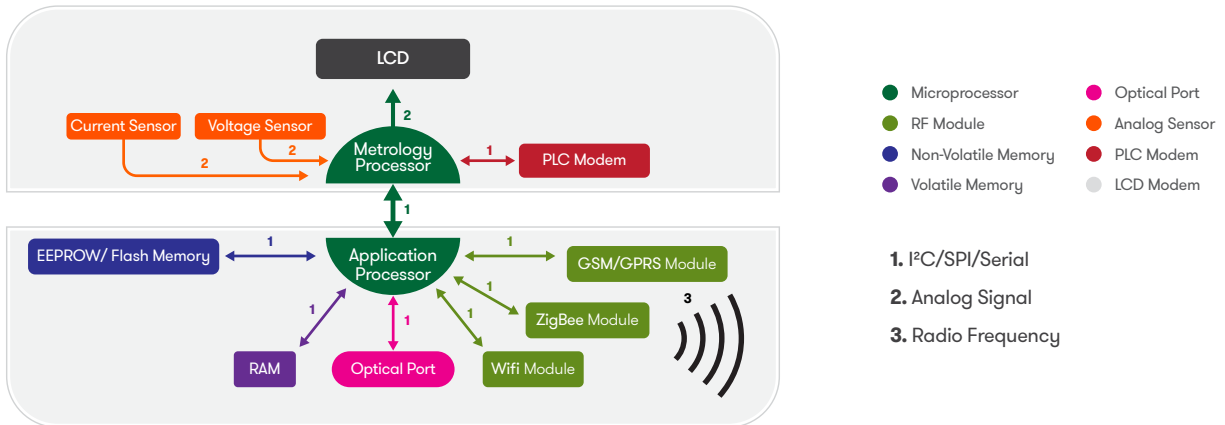

Structure of a smart meter

VISOR

Visualisation of Real Time System Dynamics using Enhanced Monitoring

VISOR is a ScottishPower project funded by the regulator OFGEM through its NIC (Network Innovation Competition) programme.

The goal of this project is to develop a global monitoring system (WAMS) for the UK's transmission grid, which encompasses 3 separate Transmission Owners (TO). Combining synchronised measurements from all three TOs to improve visibility of dynamic system behaviour and enhance network resilience, increase network capacity and deliver savings to customers.

The project is underpinned by a groundbreaking data acquisition infrastructure consisting of new monitoring units, data centres and dedicated servers, communicating via a new high-performance communication link between the three transmission operators in Scotland and England.

VISOR will also provide the system operator with the ability and confidence to harness the full capacity of the grid where increasing volumes of wind generation lead to more volatile system flows, resulting in greater operating margins to maintain and manage grid security.

The WAMS will also give transmission grid owners a risk mitigation measure during periods of uncertainty to protect the grid from low-probability, high-impact events which could generate a partial or total system failure.

FITNESS

Future Intelligent Transmission Network Substation

ScottishPower's FITNESS project, part of the NIC (Network Innovation Competition) programme, aims to demonstrate the sustainable design, deployment and operational control of a multi-vendor digital substation using the latest protection, control and information technologies.

The challenge addressed in this project is to demonstrate that innovative digital solutions for substations can be applied in a standard, scalable approach, suitable for future Business-as-Usual (BaU) implementation, delivering improved network performance, capability and flexibility at a lower cost.

FITNESS will ensure interoperability, intelligence and visibility in transmission operations and will aim to:

- Demonstrate that new protection and automation solutions, based on the IEC 61850-9-2 process bus standard, are applicable for use on the transmission network.
- Demonstrate that innovative solutions will be interoperable with the existing conventional system to optimise asset replacement.
- Move towards a future modernisation approach with reduced primary plant outage and commissioning time.
- Move towards standardised wide area control implementation leading to robust and less bespoke solutions for increasing asset capacity.

The benefits of FITNESS include a reduction in substation construction/modernisation costs, reduced outage time and restrictions, increased safety, less environmental impact and increased operational flexibility, leading to more efficient use of assets.

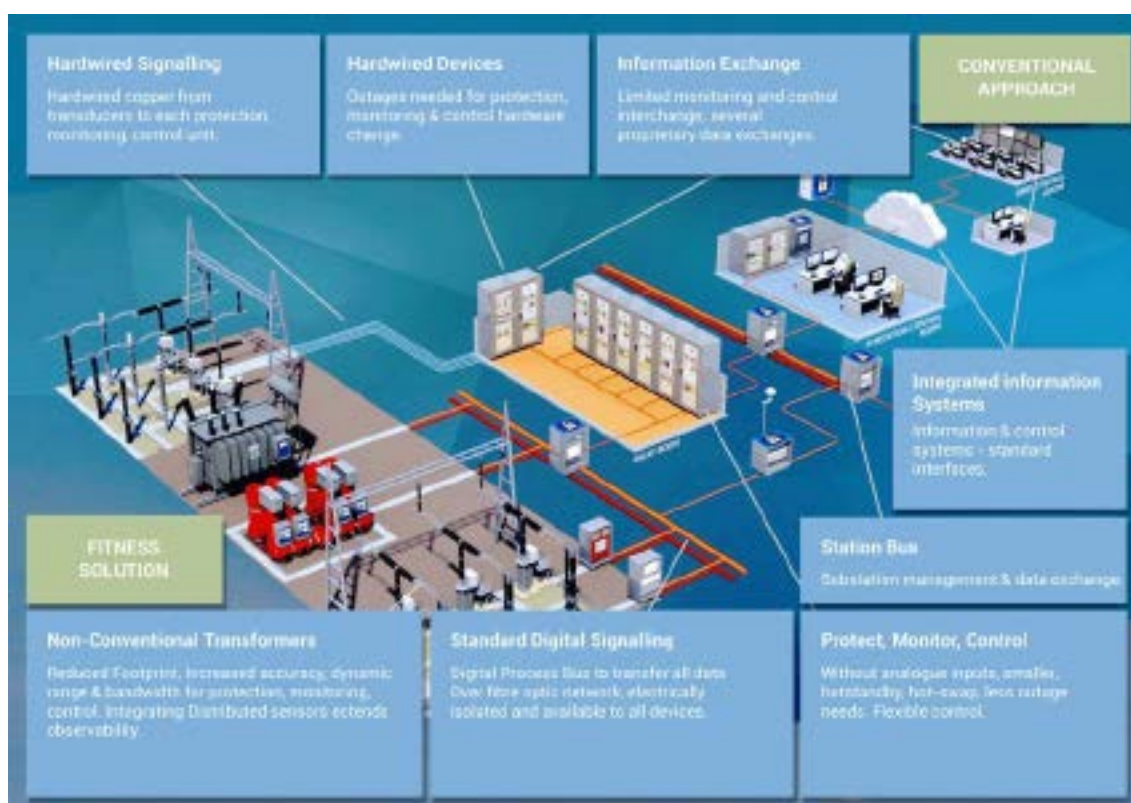

FUSION

The penetration of renewable energies and the new role of consumers as active agents in the energy system is creating big challenges for distribution networks. Renewing the infrastructure is not enough to effectively satisfy users' new needs and this makes it necessary to begin to explore and use the flexibility of the energy system as a whole.

This is the motivation for ScottishPower to carry out the Fusion project, which aims to implement a market with structured, open and local flexibility in East Fife. Fusion is designed to allow DNOs to make use of the flexibility created by prosumers, who are increasingly involved in sourcing and generating their own energy. Specifically:

- It will evaluate the feasibility, costs and benefits of implementing a common flexibility market framework based on the Universal Smart Energy Framework (USEF) model to manage local distribution network constraints and support wider national network balancing requirements.
- Investigate a range of commercial mechanisms to encourage flexibility from energy consumers' use of multi-vector electrical applications in satisfying overall energy use.
- Explore the potential for using demand-side flexibility to accelerate new connections to the network that otherwise would require new distribution infrastructures.

LV ENGINE

The LV Engine project, developed by ScottishPower, aims to conduct a trial of solid state transformers (SSTs) at secondary substations. LV Engine is designed to enhance network flexibility and release additional capacity within the existing low voltage infrastructure and facilitate the uptake of low carbon technologies, including electric vehicles and solar panels. It is aimed at 11 kV low voltage SPEN networks, which present some of the biggest opportunities and challenges when it comes to advancing toward a more flexible system.

The outcomes of this trial will lead to technical guidance documents and methodologies to inform the optimal selection of secondary transformers and the functionality required at secondary substations given the local LV network characteristics and requirements.

LV Engine will significantly enhance the flexibility and adaptability of LV networks to facilitate the uptake of LCTs whilst avoiding costly network reinforcement. LV Engine will enable the following:

- Active operation of LV networks.
- Better utilisation of existing network infrastructure.
- Facilitate the integration of LCTs at LVAC & LVDC.
- Support the DSO transition.

THIS project will deliver significant savings to customers by enabling the uptake of LCTs within the 11 kV & LV networks.

LV Engine will demonstrate how SSTs can be a more competitive alternative to conventional reinforcement, whilst stimulating a competitive market place for power electronics & SSTs within UK distribution networks.

SPEN Project

ScottishPower will develop the SPEN project, funded under the Innovation Roll-Out Mechanism, with the aim of implementing an active management system for the distribution and transmission networks in Dumfries and Galloway, Scotland, and establishing new relationships with customers, in real time.

The project will also allow monitoring of network capacity while adapting to the production of local energy generation. This will benefit renewable current and future energy producers of any size and will help achieve the objective of reducing carbon emissions.

Dumfries and Galloway has among the UK's highest proportion of connected renewable generation relative to local demand for energy. That can present difficulties when it comes to exporting renewable energy back to the electricity grid and connecting new projects.

This project will allow the limited existing generation to increase production by approximately 90 MW. Furthermore, 200 MW of additional generation will be installed for connection and export, as well as to feed a network of more than 100,000 electric vehicles in the future.

PHOENIX

The aim is to develop a new hybrid-synchronous compensator to allow greater use of renewable energy in situations of conventional generation constraint. The project is based on a sustainable design, deployment and operational control of a Synchronous Compensator with innovative hybrid control system combined with a static compensator.

The use of these devices will mitigate serious system issues that are being encountered on the transmission network as a result of the progressive closure of synchronous generation plants.

The project will provide an efficient and combined solution to improve system stability and security while maintaining energy quality, reducing the risk of power cuts and providing significant benefits to customers.

Woodbridge Microgrid

Woodbridge Microgrid and Amity Fuel Cell

AVANGRID and its subsidiary United Illuminating (UI) have launched this project to develop a microgrid with fuel cell in Woodbridge, Connecticut. In recent years, energy companies in Connecticut have responded to regulatory challenges requiring innovative ways of increasing the state's access to clean energy generation sources and improving system reliability in emergency situations, such as the power failures caused by Tropical Storm Irene and Superstorm Sandy in 2011 and 2012.

The fuel cell converts natural gas into electricity and heat using a highly efficient electrochemical process which does not require combustion and therefore does not generate the emissions associated with it. Under normal operating conditions, the fuel cell will contribute 2.2 megawatts of renewable energy to the state's electricity grid. In adverse weather conditions or during prolonged power outages, the system will be islanded from the main grid to provide energy to seven critical buildings including the local high school, the town hall, library, fire station, public works facility and old people's centre/emergency shelters and public facilities. This unique and innovative solution has never been implemented before in a municipal community microgrid.

The project began in 2013 and was completed in 2018, achieving the following goals:

- Develop a municipal microgrid to back up critical installations during extreme weather conditions and demonstrate the benefits for utilities of operating microgrids.
- Operate the microgrid in island mode in critical situations to guarantee the electricity supply during extreme weather events.
- Gain experience in the functioning of microgrids in both island and conventional modes, connected to the central grid.
- Ensure compliance with regulatory requirements CT PA 12-148, section 7 and CT PA 11-80, section 127.



ESC

Energy Smart Community

The purpose of the Energy Smart Community (ESC) programme is to design and implement the smart grid of the future –more flexible, reliable and with greater response capacity. It will serve as a driving force for initiatives and technology that will help Avangrid act as a Distribution Systems Platform (DSP) and will involve a new collaboration channel with electricity system stakeholders, academia and the main players in the market.

The Energy Smart Community consists of three program elements with ten projects covering various topics: improving grid and distributed energy resource management, and the ability to respond to demand and the customer experience by offering a wider range of products and greater control over consumption. The programme aims to tackle the principal challenges that energy distribution companies face:

1. Implement new processes and tools for the integrated planning of the distribution system (“Integrated System Planning”).
2. Support the commitment of customers and third parties in market operations (“Market Enablement”).
3. Operate the grid efficiently and reliably (“Grid Operations”).

The main objectives are as follows:

1. Test and demonstrate the functionality of key technology platforms (grids and systems).
2. Develop new capacities and process to support the evolution of a smart distributed system platform that integrates operations, planning and market performance.
3. Create and test new tariff/rate/fee designs to support the efficiency of the system.
4. Design and test new methods for creating value for customers.
5. Identify new ways of interacting with the market.
6. Create an environment of cooperation.
7. Support and inform clean energy policies.

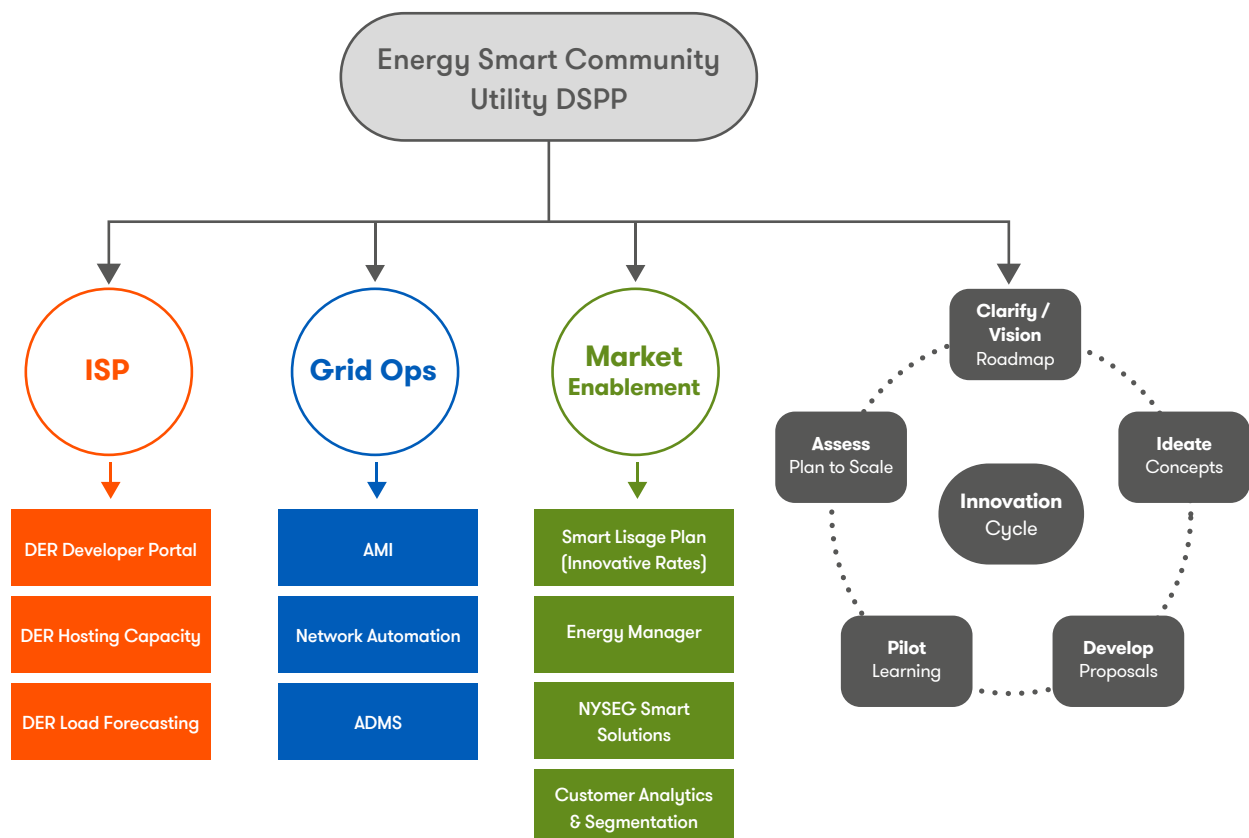

The programme was approved for \$26.4M: 10M\$ for Advanced Measuring Infrastructure (AMI), 8.8M\$ for investments (CAPEX), 7,6M\$ for Operating Expenses (OPEX) and 5M\$ for automation. 12,500 electric smart meters, 7,300 smart gas meters, 4 substations and 15 feeders have been installed in Ithaca, NY.

DG Microgrids

Distributed generation with alternative and renewable energy sources in the area of microgrids. Smart grid: measuring methods, operational safety and impact on energy quality

The purpose of this Neoenergia project is to develop software to analyse errors in smart electricity meters, taking into account the latest techniques for measuring active and reactive energy, with a particular focus on reactive energy, and taking into account non-linear loads and distributed generation scenarios (microgrids with renewable sources). The project also considers new distribution scenarios involving microgrids and is developing software that integrates methods of comparing both scenarios with the register from this equipment.

Developing technology to insert microgrid into isolated systems.

Microgrids

The objective of this Neoenergia R&D project is to study the application of isolated microgrids as a large-scale solution for universal access to energy, focusing on minimising investments and maximising the social and economic benefits for newly electrified communities.

Six pilot projects with commercial technologies will be implemented in remote communities in the Brazilian state of Bahia. There will be three plants with a “conventional” solution (plant with hybrid photovoltaic panels, battery bank and backup with diesel generation) and three plants with an “alternative” solution (photovoltaic panels with batteries and no diesel backup). These pilots will be set up in communities of different sizes (small, medium and large), with and without public lighting. Furthermore, a microgrid will be developed in the laboratory with hybrid energy storage using supercapacitors.

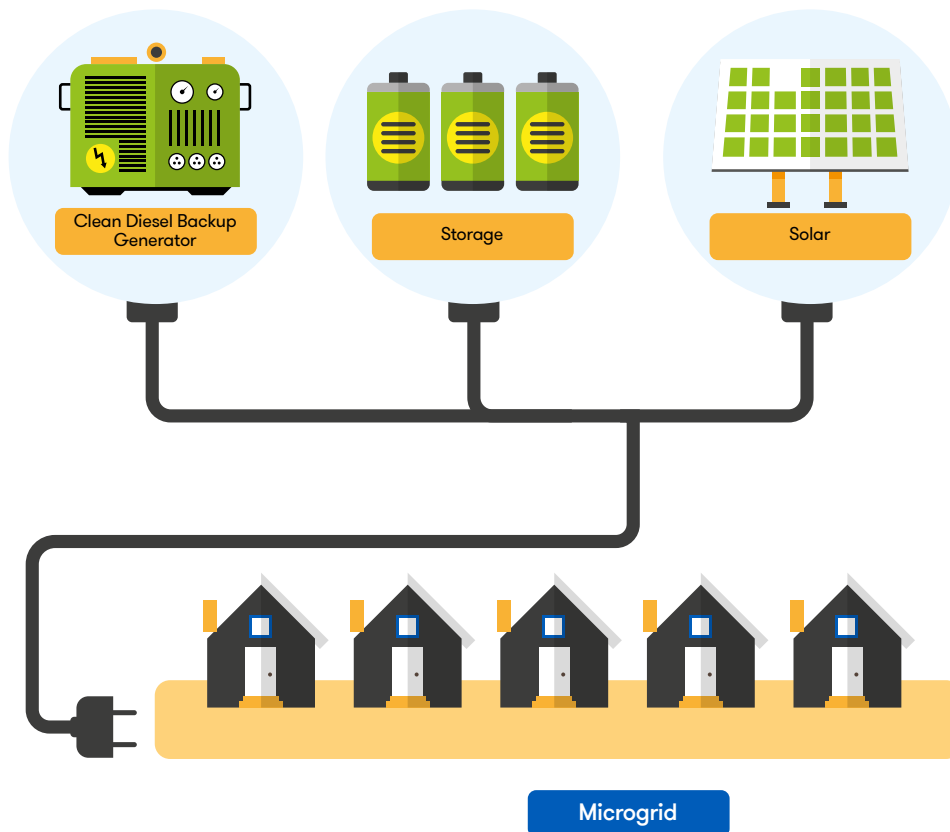

Plant with diesel backup

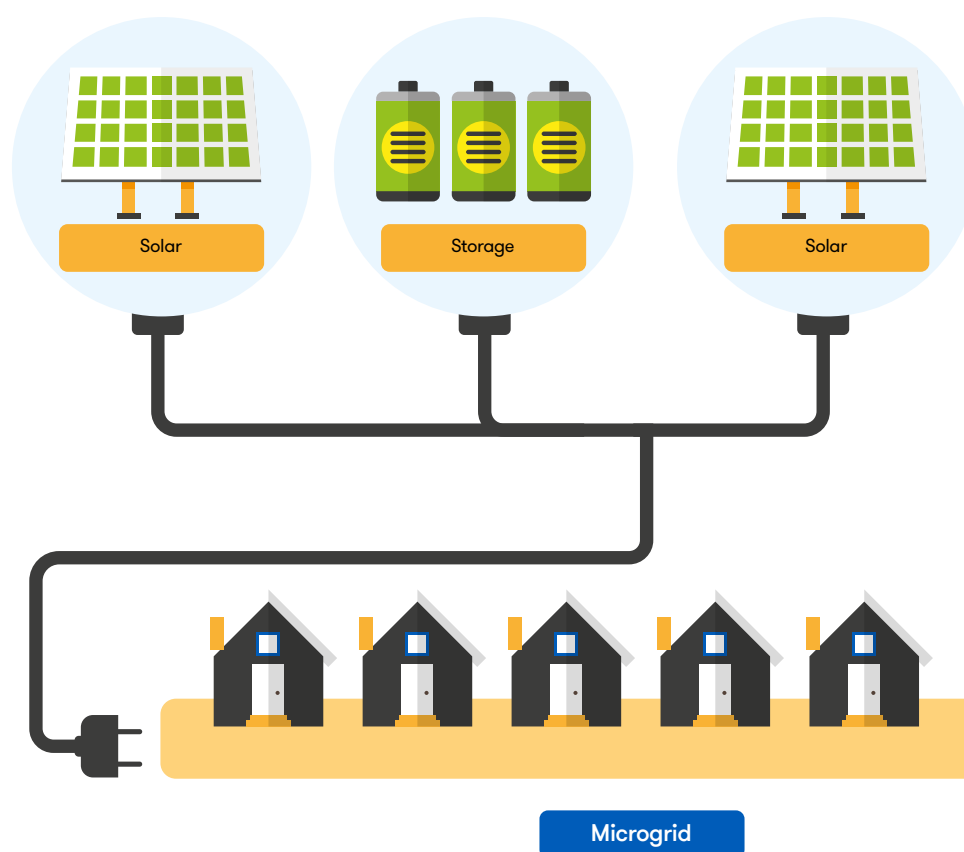

Plant with solar backup

The influence of these pilot plants on the environment will be monitored, as will the social progress of the communities, using specific indicators to measure the real impact of electrification on their quality of life. The aim is to include supercapacitors in microgrids along with batteries by designing a hybrid energy storage system as a possible solution to reduce operational costs, given the useful life potential of these batteries in adverse conditions.

The data obtained from the pilot plants, the results obtained from the laboratory trials on the performance of the equipment and the simulations of the new technology proposed must prove the assumptions adopted. They must also allow the risks to be analysed to validate a functional approach to energy supply with less investment and more efficiency for the electrification of remote rural communities. They could also be used to establish the institutional basis to replicating the solution on a larger scale with the aim of achieving universal access to electricity in other remote areas of Brazil.

Development of a low voltage regulator to achieve temporary voltage levels

Low voltage regulator

The purpose of this Neoenergia project is to develop equipment to solve temporary voltage level problems using technologies which reduce weight, volume and costs, facilitate installation and integrated measuring and provide a remote communication device for monitoring by the company and the consumer.

As a result of the project, two low voltage regulators have been obtained, one with series topology and one with parallel topology.

Atibaia Smart City – Pilot Project

Implementation of high-end technology in the energy process of the city

This Neoenergia project is an essential part of Brazil’s digitisation plan, which will see full deployment of smart grids by the end of 2030. The project began in 2017 and by 2020, 75,000 customers in the region of Atibaia and nearby cities (Bom Jesus dos Perdões y Nazaré Paulista) will benefit from the implementation of various smart grid technologies which will allow the operation of this area using a DSO (Distribution System Operator) model.

The scope of the project includes the implementation of 75,000 smart meters using PLC PRIME and RF WiSUN technologies, together with a smart automation system covering more than 100 points. More than 45 km of new grids are being built to improve the benefits of this automation. All of the equipment’s communication needs will be met by a private LTE network covering an extensive area of the region. These applications are the framework that will allow increased penetration of distributed generation, which, with the incentives given by Elektro, is being deployed widely, making Atibaia the point of reference for solar power in Brazil.

This new operation model offers better quality of service in terms of the number and duration of interruptions, which will be automatically detected by smart meters and isolated by reconnectors coordinated by the smart system. The remote management of consumption at service points and transformers will allow losses anywhere in the grid to be evaluated and daily measurements will be available so that customers can manage their energy consumption.



GRID+STORAGE

Supporting the R&D strategy in the area of Smart Grids and storage as part of the SET Plan

The project has resulted in consolidated points of view on future R&D&i needs related to technological development and the adaptation of the electricity market:

- Support the development of European electricity grids and energy storage,
- Make these networks use energy storage solutions in order to increase the flexibility of the European electricity system with the aim of achieving greater inclusion of renewable electricity generation, among other objectives.
- Facilitate a technological basis to activate the “active customer” as another source of potential flexibility for the energy system.
- Optimise the interactions of these grids with other energy networks.

Asset management

UG PILC Cable maintenance

Optimising the asset management of the oil-impregnated, lead coated (PILC) MV cable infrastructure

The purpose of the project is to create a tool to prioritise the replacement of oil impregnated, lead coated (PILC) MV cables. To accomplish this, the following actions will take place:

- Monitoring and profiling MV PILC cables.
- Condition of MV PILC cables.
- Identify the operating and service conditions of MV PILC cables within the system to optimise their reliability.
- Analyse the feasibility of BPL communications as a system to actively monitor the degradation and ageing of MV PILC cables.
- In conjunction with manufacturers, promote a prototype to detect autoextinguished faults in MV PILC cables.

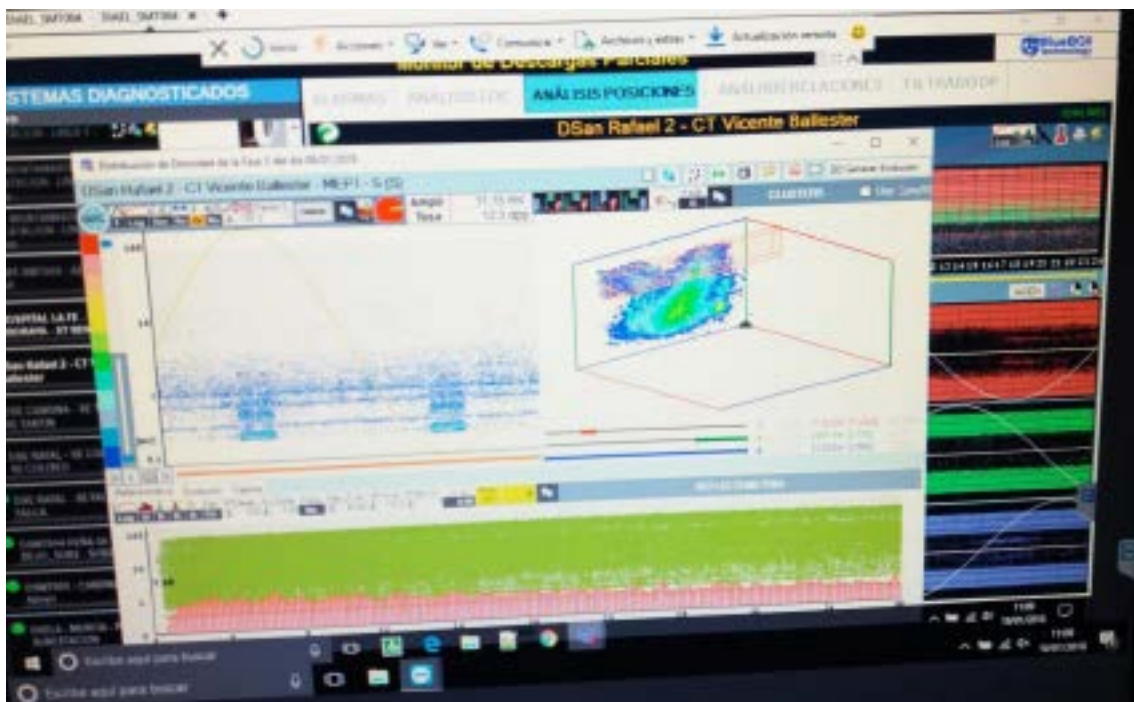

MATSALEN

Tool for determining the ageing of medium-voltage cables in underground power distribution lines.

This project was carried out as part of the Spanish Ministry of Economy and Business RETOS COLABORACION programme. Its aim was to develop an advanced interoperable technological solution featuring cutting-edge hardware and an innovative system for estimating the wear on medium-voltage cables found in underground power grids, thus improving the way the assets are managed and enabling an optimum roll-out of future smart grids.

The project focuses on the ageing and wear of both cables and instrumentation (sensors used to run system self-diagnostics and provide historical data) within the smart grid in order to offer an innovative one-stop solution for managing medium-voltage electrical assets. The technology can easily be exported and adapted to international power grids.

SILECTRIC

Development of materials for power line insulators and electrical switchgear for extreme conditions and to ensure a long useful life in medium-voltage systems.

This project was carried out as part of the Spanish Ministry of Economy and Business RETOS COLABORACION programme. Its goal was to obtain new insulators for high-voltage lines and switchgear with improved properties for environments with extreme operating conditions where ageing processes are more pronounced. This also helped to improve the quality of supply and the efficiency of power distribution networks by reducing the number of outages affecting polymer line insulators.

The results of this project will allow substantial quality improvements to elements installed in grids. Measurable short-term benefits include improved materials that can outperform traditional silicon components under trial conditions, while the medium-term benefits will include a reduction in line insulator failures as part of the strategy of continuously improving quality of service.

Drone Pilots

Unmanned Aerial Systems (UAS) – AVANGRID’s Experience

Unmanned aerial systems or drones have become one of the most widely used tools for conducting inspections of electricity infrastructure, replacing traditional inspection methods like visual inspections on foot or in situ inspections by climbing. These systems are mainly being used to continuously improve preventive and predictive maintenance. The potential applications of drones are endless, and are improving safety, efficiency and reliability.

Several AVANGRID subsidiaries, such as NYSEG, RG&E, CMP (Central Maine Power) and UI, have used drones to conduct pilot inspections of transmission assets and substations, with excellent results.

CMP has also experimented with the use of drones as part of its damage assessment programme following adverse weather events. After destructive storms or disaster conditions like floods or heavy snowfall, drones allow inaccessible resources to be monitored quickly, safely and efficiently. Drones are also capable of taking photos/videos and providing very precise GPS coordinates to record the location of the damage.

NYSEG is currently evaluating multiple applications in collaboration with entities like NASA. One of these applications is the use of methane leak detection sensors that can efficiently operate above the tree line. It is also evaluating different sensors with cameras to identify metal corrosion and pitting using infra-red or high-pixel photography. In 2016, NYSEG ran a pilot to conduct predictive inspections at its Upper Mechanicville Hydroelectric Plant in upstate New York, with good results.

The demand for drone operations in recent years has led to technology advancements that have reduced the cost of the equipment as well as simplified their use. Some utilities have even opted to develop their own internal technology. In 2016, UI ran a pilot using drones to inspect its transmission assets. After evaluating the results and comparing the costs to climbing inspections, UI decided to invest in two drones with video and infra-red cameras. UI also invested in drone pilot training and certification for two of its employees within the Process and Technology organization.

The main applications of drones in the energy sector include:

- Monitoring inspections using infra-red. High-voltage lines are usually inspected periodically from helicopters using infra-red technology. However, it may be necessary to conduct unscheduled inspections in certain situations or after unforeseen events. Drone inspections allow lines to be viewed from different angles and allow images to be captured, preventing the need to use a helicopter.
- Bird nest evaluation: Often eliminating the nests is necessary to prevent pole fires or high voltage line faults. Drones can be used to inspect and take photos of the inside of bird nests to evaluate whether they should be removed in accordance with local environmental regulations.

- Inaccessible locations: Often, structures must be built above watercourses or wetlands affected by fluctuating tides. Due to these and other terrain conditions, drones eliminate the need to use aquatic transport methods to conduct inspections in these locations.
- Inspection of substation roofs: Due to the proximity of transmission lines to the roofs of some substations, it is often necessary to disconnect the line in order to inspect the substation. Drones can be very useful in these situations.
- Inspections of substation equipment: It is often necessary to stop equipment to inspect substations at great heights and to use lifts to access them. Drones facilitate access to information on nameplates, inspection of switches, etc.
- Inspections of solar farms: Solar panels are inspected from above using IR technology. Drones are capable of quickly and efficiently identifying defective solar panels and hotspots.
- Operations inspection request: Inspections are often requested following unforeseen situations. In most cases, foot patrols are necessary to restore lines. Drones can be used to detect and locate faults and facilitate the decision making process.
- Evaluating storm damage: After destructive storms or disaster conditions such as floods or heavy snowfall, utility companies can use drones to inspect hard-to-reach locations.



Device to monitor the remaining useful life of stationary lead-acid batteries in substations and distribution switches

Development of a device to estimate the useful life of lead-acid batteries

The overarching objective of this Neoenergia project is to develop a device to monitor the status of a battery bank and estimate its remaining useful life.

The project is highly applicable to substations that use stationary lead-acid batteries, reducing failures and costs and improving service. In addition, the device can be used by any company in the electricity or telecommunications sectors or any company that requires energy, such as banks, retail, hospitals, etc.

Vegetable oil for distribution transformers

Adoption of a vegetable oil-based insulator for distribution transformers to replace mineral oil, which is still widely used.

In the attempt to improve distribution transformers using new technologies available on the market, the adoption of vegetable insulating oil for distribution transformers can result in increased useful life, operational safety and ecological sustainability while reducing the environmental impact.

Non-toxic, non-flammable and biodegradable, vegetable transformer oil results in improvements to the fire safety system in a way which is respectful to the environment, extending the useful life of equipment by up to 30% and overloading capability by up to 15% without lifetime reduction.

Possible applications in distribution networks include using pole-mounted transformers with vegetable oil to replace conventional transformers containing mineral oil. These transformers are considered to be feasible due to an excellent cost-benefit ratio with low price difference compared to mineral oil transformers.

Operating Systems

LAYCA

System to detect and profile faults in medium-voltage networks.

This project, which has been funded by CDTI, aims to develop a high-precision system to profile and solve problems in medium-voltage electricity distribution networks. To achieve this, an algorithm will be developed to determine grid impedances during a fault in a line from oscilloscope readings provided by protection relays on the affected node.

The main activities of the project are:

- Research and development of digital processing of oscilloscope signals to create algorithms to calculate voltage and current signal impedance with enough stability to ensure reliable functioning.
- Analysis of the accuracy of current fault detection algorithms for MV distribution networks as well as proposing improvements to existing algorithms and developing new algorithms to calculate impedance in the frequency domain.
- Developing a strategy and an algorithm to estimate impedance based on recursive calculations applied to the time domain.



Detection of losses using hourly load curves

Analytic models to detect non-technical losses using hourly load curves and events.

The overall aim of the project is to develop a predictive solution to detect non-technical losses in the electricity distribution network. These models will be built using machine learning statistical methods (gradient boosting) and the information from load curves generated by smart meters will be used, along with other information related to the contract.

NFC Project

Platform using NFC technology to automatically control functional processes in primary and secondary substations.

The overall objective of the project is to develop a software platform based on NFC technology to control assets (inventory and traceability) and to design safety procedures in distribution network transformer centres with identification of electronic and electric elements using passive tags.

This project will allow Iberdrola Distribución to:

- Improve the safety of manoeuvres for its operators in transformation centres.
- Improve the quality of existing inventory data.
- Improve the traceability of assets.
- Improve efficiency and minimise failures existing in processes.
- Reduce the time and resources that need to be invested to carry out tasks related to Iberdrola assets.

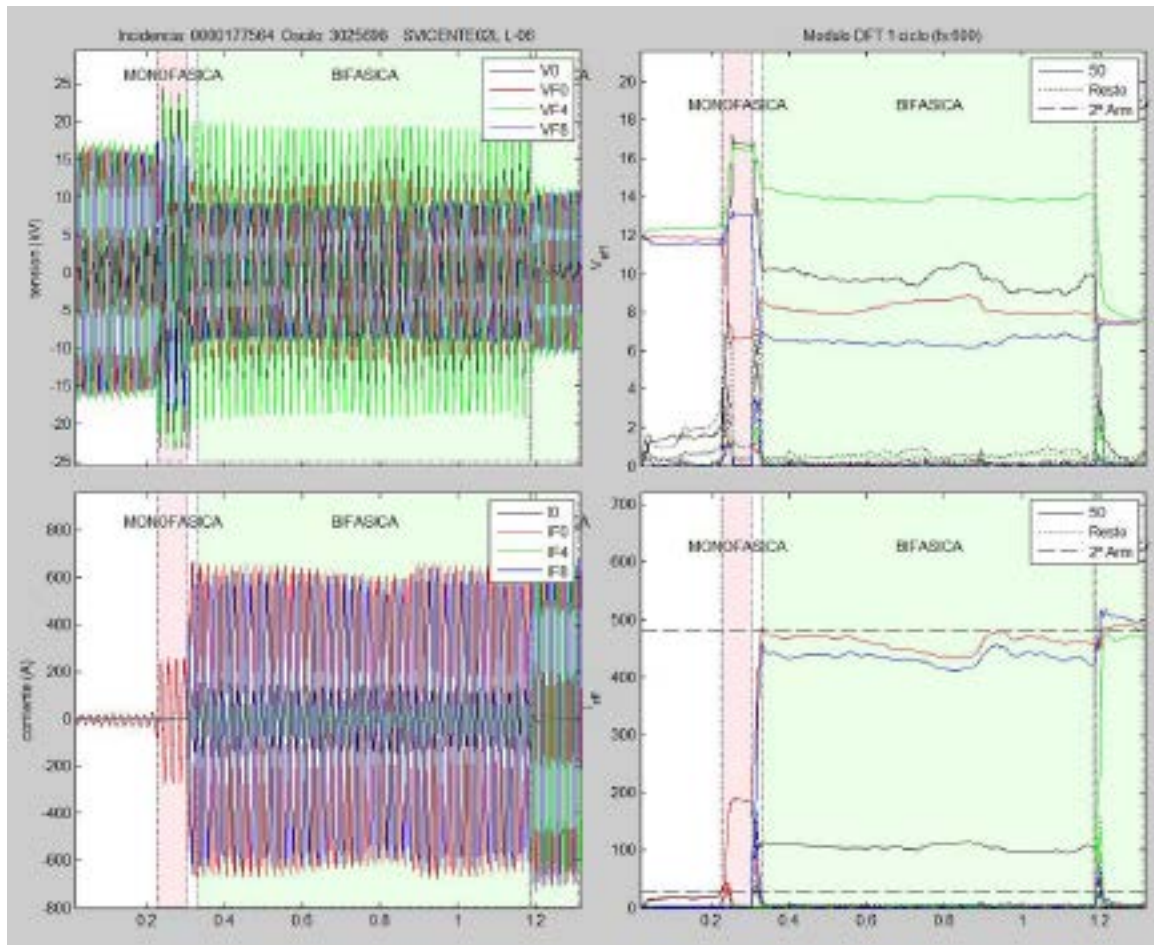

GENESIS

New GIS Distribution system

The aim of the project is to implement a new graphic system that supports the Technical Inventory of the Iberdrola network, and its integration with the rest of the systems supporting key business processes (Operation, Planning, Construction, Maintenance and Supply Point Management).

The future system will:

- Enable compliance with the new requirements arising from the current regulatory framework and help improve the efficiency of the business, based on the technological upgrades to the new platform.
- Improve the integration of the new system within the organisation's systems map, thereby reducing support and maintenance operating costs.

RMS

New Remote Management System

The aim of this project was to develop and validate the new Remote Management System (RMS) that will provide instant and reliable access to the necessary information, integrating various modules to efficiently manage the electricity grid and meter park. The system boasts new functionalities for ensuring support that is sustainable over time as well as for its continuous evaluation, thereby creating a stand-alone platform and taking advantage of the current advantages afforded by smart grids.

Apart from its greater capacity and tailoring to the needs of the business, another major advantage is its integration with Titanium (field access interface) and STGWeb, whereby users can do everything via STGWeb with direct field access (always with the appropriate security). This, combined with greater real-time integration, allows further development in line with Iberdrola's vision of smart grids.

Harmonic Sharing Responsibility

Modified superposition method for sharing harmonic distortion among agents in the electricity system

This project will develop the methods and equipment necessary for the practical application of the modified superposition method in order to efficiently and reliably share harmonic distortion in the Brazilian national grid among agents in the electricity system (generation, distribution, transmission and other load units), in order to resolve an emerging problem in the current Brazilian electricity scenario.

Public maps of network capacity in the planning phase

The purpose of this project is to facilitate the integration of distributed renewable generation. The intention is to give more visibility to available network capacity, improving the management of network connection volumes.

Begun in 2017, the specific objectives of the project are to:

- Develop a graphic network analysis tool.
- Determine the capacity of the network to integrate new loads.
- Automatically calculate non-guaranteed power.
- Design a simulation model for HV/EHV networks.
- Define MV network capacity by section.
- Include the integration of zones into the MV model.

The expected results include improved planning of new investments, a reduction in connection volumes in very restricted zones, and integration of new tools into corporate systems.

Service Quality

CARTOLIDAR

The objective of the CARTOLIDAR project is to:

- Use LIDAR technology, photometry and helicopter-mounted equipment to improve line inventory and map the vegetation underneath and surrounding power lines.
- Review aerial power lines using a helicopter including regulatory inspection, thermography and a LIDAR sensor to improve line inventory, identify anomalies and the vegetation underneath the line and determine its growth.

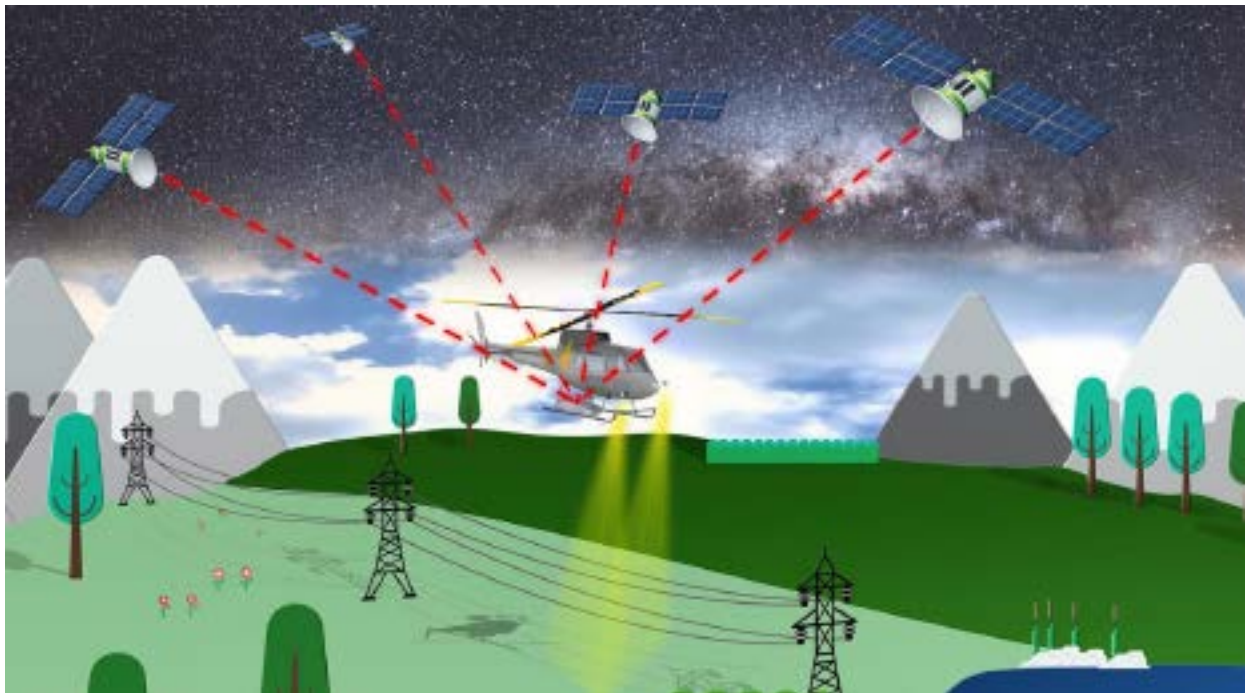

Pruning

Robotic pruning for network maintenance

This project is one of the initiatives being carried out by Neoenergia to increase the safety and reliability of its urban network infrastructure, taking environmental factors into account.

It consists of a robotic system with an insulated articulated telescopic arm which can be integrated into vehicles and can incorporate a variety of tools (such as a hydraulic saw) to remotely control vegetation surrounding the network. The vehicle transporting the robotic arm also has a vegetation shredder and waste storage installed. These developments have improved the performance of pruning equipment and operator safety.



Truck with robotic system with extensible arm coupled

Measuring grounding resistance in substations

With this project, Neoenergia aims to develop a compact source to measure grounding resistance in substations.

The equipment will inject a standard configurable current with a maximum value of 15 A, with adjustable frequency and voltage, within the range of 50 to 100 Hz (resolution of 1 Hz) and 60 to 300 V (resolution of 1 V). It is able to receive commands or have the information on the variables involved in the measurements (current, voltage and frequency) monitored or configured remotely by a wireless monitoring and control station with a communication range of up to 4 km.

D-TCSC (Distributed Thyristor-Controlled Series Compensator)

D-TCSC (Distributed Thyristor-Controlled Series Compensator) for the Elektro distribution system

A prototype D-TCSC (Distributed Thyristor-Controlled Series Compensator) was implemented for the Elektro distribution system. The use of D-TCSC as a dynamic voltage regulator reduces voltage fluctuations, improving the quality of the energy available to the end user. This reduces the possibility of damage caused by voltage variations.

The possible use of the compensator as additional protection against short circuits, yet to be explored, can also reduce the damage caused by these eventualities, as well as reducing the time and frequency of disconnections as a result of the protection.



Lasers to keep the lights on

During storms, one of the main causes of power cuts is fallen trees and broken branches colliding with overhead lines. This project, being carried out by ScottishPower, aims to draw up interactive 3D maps of the networks in Scotland, Merseyside and North Wales, with the intention of optimising operation and maintenance tasks and safeguarding the energy supply in adverse weather conditions, limiting the damage to the grid.

In the project, ScottishPower will deploy fixed-wing aircraft using 3D laser scanning technology to create detailed interactive models of its network to precisely highlight the exact locations of individual trees next to its power lines. This will allow the company to record the exact location of trees, plot their growth and plan maintenance. This will reduce the number of homes affected by power cuts during winter storms and minimise reconnection times.

The system also takes account of regional variations, such as the different rates of growth of vegetation between Wales and Scotland.

Thanks to investments made in the past decade in the maintenance of vegetation beside aerial power lines, power cuts have been reduced by up to 25%. This project aims to reduce this percentage even more.



Cliente

The aim of this project is to change the current culture, which is mainly focused on process efficiency, to a new innovative customer-focused organisation, while maintaining our efficiency.

The following actions are currently under way:

- Flexible IVR: Provide the IVR (Interactive Voice Response) system with a logical activation/deactivation process depending on agent availability.
- Proactive detection of low-voltage faults based on smart meter events: Detection without calls from customers.
- Automatic response to energy bill complaints.
- Improve customer experience through digital channels: new website, app, EV microsite, and video tutorials.

The results of this project will improve customer satisfaction, enhance the overall service by improving the efficiency and flexibility of the call centre and reduce service restoration and complaint resolution times.



Camino del Cliente

Nuevos suministros

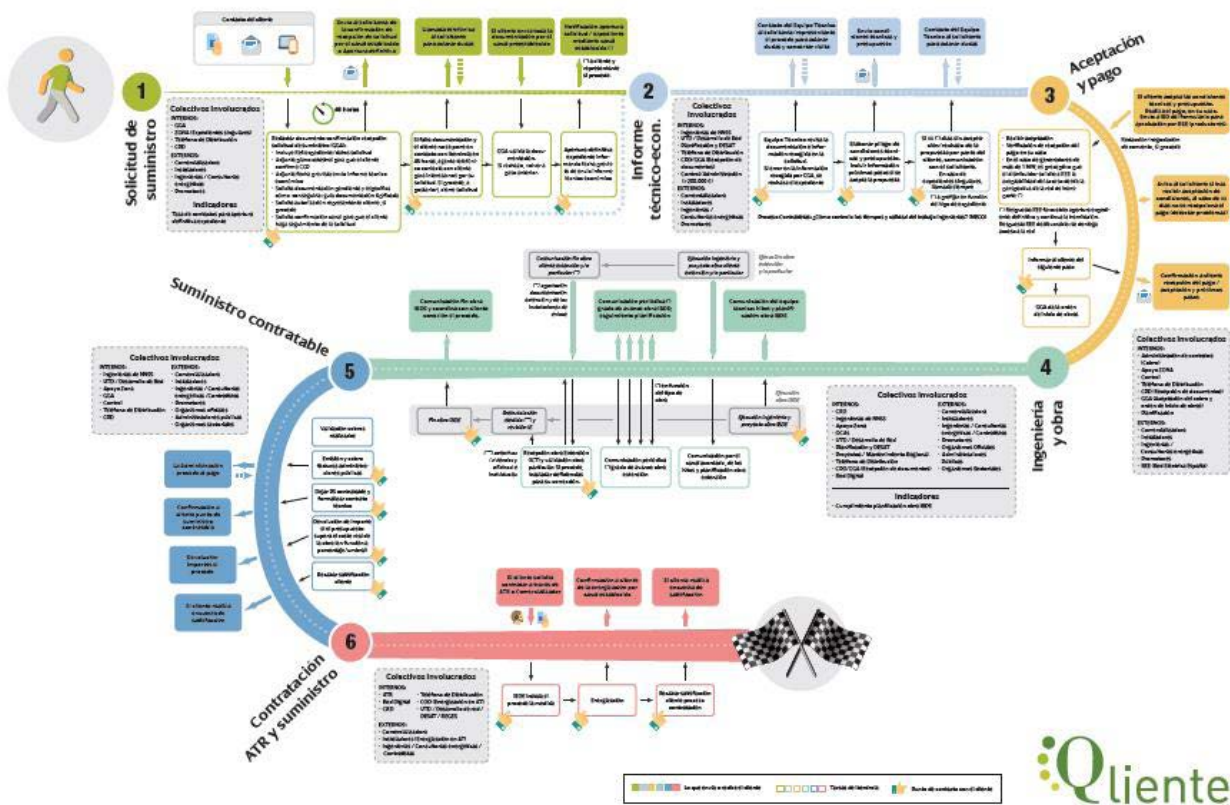

New technology for vegetation removal

This Neoenergia project aims to develop new methods, tools and equipment to further mechanise vegetation removal and make it more efficient. Adopting technology into the vegetation management process makes it possible to improve performance and generate benefits such as service quality and safety.

The use of Bobcat equipment makes it easier to access heavily forested areas and provides a much better result than the usual method of manually removing vegetation. Trees and bushes are converted into a layer of mulch which may halt vegetation growth and does not need to be collected.

The reinforced glass cabin protects the driver from pieces of wood colliding with the cabin and can also be operated remotely, increasing employee safety.

TITAM-BT

New fraud detection equipment

The aim of this project is to minimise meter fraud and ensure the correct billing of Neoenergia customers. Based on studies of meters, the project aims to develop equipment capable of protecting energy meters factoring in protection against non-technical losses in distribution, regulations, efficiency and cost reduction. The project will also reduce meter installation times by 50%.

Concept testing was conducted to evaluate the project in a group of customers with recurring problems with fraud. The results were monitored for three months and at the end of the twelve-month period, no further cases of fraud were detected. The project was implemented by Elektro in 2017 and 2018 and showed excellent results. These positive results led the company to implement TITAM in other Neoenergia business areas throughout Brazil.



Disconnection devices

Like the previous project, the aim is to identify fraud and improve energy efficiency. To do this, new selector switch devices will be installed in isolated areas in Brazil. These devices, installed at strategic locations, will be capable of isolating sections and subsystems in the electrical circuits.

New equipment and materials

Advanced Portable Monitoring

The purpose of this project is to design advanced portable monitoring equipment with loss detection algorithms based on energy balance in low-voltage networks. This will improve the operational needs of the distribution network by improving LV connectivity and obtaining information on energy balances.

DVR

Dynamic Voltage Restorer

With this project, Neoenergia has built a prototype low-cost 380V/200kVA Dynamic Voltage Restorer (DVR) able to efficiently identify power drops and surges on the grid and to connect a voltage regulator in series with the grid, so that the grid will not be affected by a voltage fluctuation.

The main challenge was achieving a technical solution that is able to prevent service disruptions through a cost-effective solution that meets supply standards. Once the testing phase was completed, the prototype was installed in the electricity grid.

Calibration of electricity meters in the field

Calibration of electricity meters without interrupting the power supply

The aim of the Cosern project is to develop new equipment able to measure and generate controlled electrical signals, based on field conditions, to safely and precisely check the condition of energy meters without disconnecting or interrupting the electricity supply.

This tool, with its improved prototype, will read meters without interrupting the customer's power supply. It does not require revalidation of the laboratory calibration, as the tests used are standardised. In addition, the tool has a number of advantageous features including the fact that the equipment can be applied to different types of meters (electronic and electromechanical, single-phase, two-phase and three-phase) and energy values with inductive and capacitive power factors can be generated in the field, facilitating the measurement and verification of meters. The device also has a manual trigger and photocell to capture pulses and tags, as well as a screen and keyboard to interact with the operator.



Reading and calibrating electricity meters.

Assessment of pole integrity

Evaluation of the structural integrity of distribution poles through dynamic monitoring

Cosern identified the opportunity to develop a dynamic portable system to monitor pole behaviour with immediate interpretation of results. The new system represents a new concept of structural integrity assessment with quantitative indicators for diagnosis, helping choose if the poles need repairing or exchanging even before the electricians are exposed to risk, even before electricians are exposed to risk.

The aim of this project is therefore to obtain sufficient information on distribution network structures to identify non-visible faults or faults which compromise employees' and people's safety before they occur.

System to detect water in transformer oil using microwaves

Development of a microwave-based sensor to detect the presence of water in transformer oil.

The objective of this project is to develop a sensor based on microwaves to monitor and detect water content in transformer oil (range of 1 ppm) through continuous (online) monitoring of substation transformers. This monitoring will considerably increase transformer reliability and useful life.

The solution is a portable system, as reliable as chromatography, which makes continuous measurements in real time using microwaves and connecting the measurement data to the company database.

R&D&i in the Renewables Area

From the beginning, Renewables has been an innovative business seeking to break with the traditional electricity production model in order to find new sustainable solutions for the planet.

Renewable energies have now been incorporated and form a substantial part of our generation technologies due to their lower cost and competitiveness compared to conventional technologies. Nevertheless, there is still a long way to achieve 100% renewable electricity generation.

Here are some of the main innovation areas in the period 2016-2018:

Improving the efficiency of our operating assets and associated processes. Extending the life of our facilities beyond their design life, reducing their costs and impact and guaranteeing their reliability. These are big challenges which require significant resources and effort year after year. Developing internal tools to analyse the reliability of components, reducing the operating and maintenance costs of major systems and reducing error rates are key actions which require continuous improvement. It is also important to predict production in order to reduce deviations from actual production levels by using tools such as machine learning. Finally, work has continued on the lines of research into the efficient management of hydraulic energy resources.

Grid integration, hybridisation of renewables and energy storage. At Iberdrola, we are analysing multiple projects to install energy storage based on batteries connected directly to the grid or using other renewable facilities. Throughout the period, a number of special tools were developed to assess specific uses of storage systems linked to renewable facilities. More specifically, the tools simulate the behaviour of batteries connected to photovoltaic installations and hybrid wind-photovoltaic systems.

Design and construction of more competitive renewable installations. Innovation in offshore wind farm projects is essential to reduce costs and limit the risks in future construction projects, as well as guaranteeing the competitiveness of the company in the current framework. Therefore, foundation optimisation projects have been carried out to analyse safety factors and cemented joint materials and research the effects of scour on offshore foundations and ways to mitigate it. Also, several HVDC systems have been developed. Finally, several activities have been carried out aimed at reducing the construction costs of photovoltaic plants, as well as analysis to optimise the main components.

Also worth noting are **initiatives aimed specifically at sustainability** and projects to detect birds and dissuade bats at wind farms.

Digital Evolution Plan 2018-2022. Iberdrola Renewables has made significant efforts in the field of digitisation in the past few years with the aim of standardising, globalising and improving process efficiency in search of operational excellence. With this objective in mind, the “Renewables Digital Evolution Plan (2018 – 2022)” was launched in 2018.

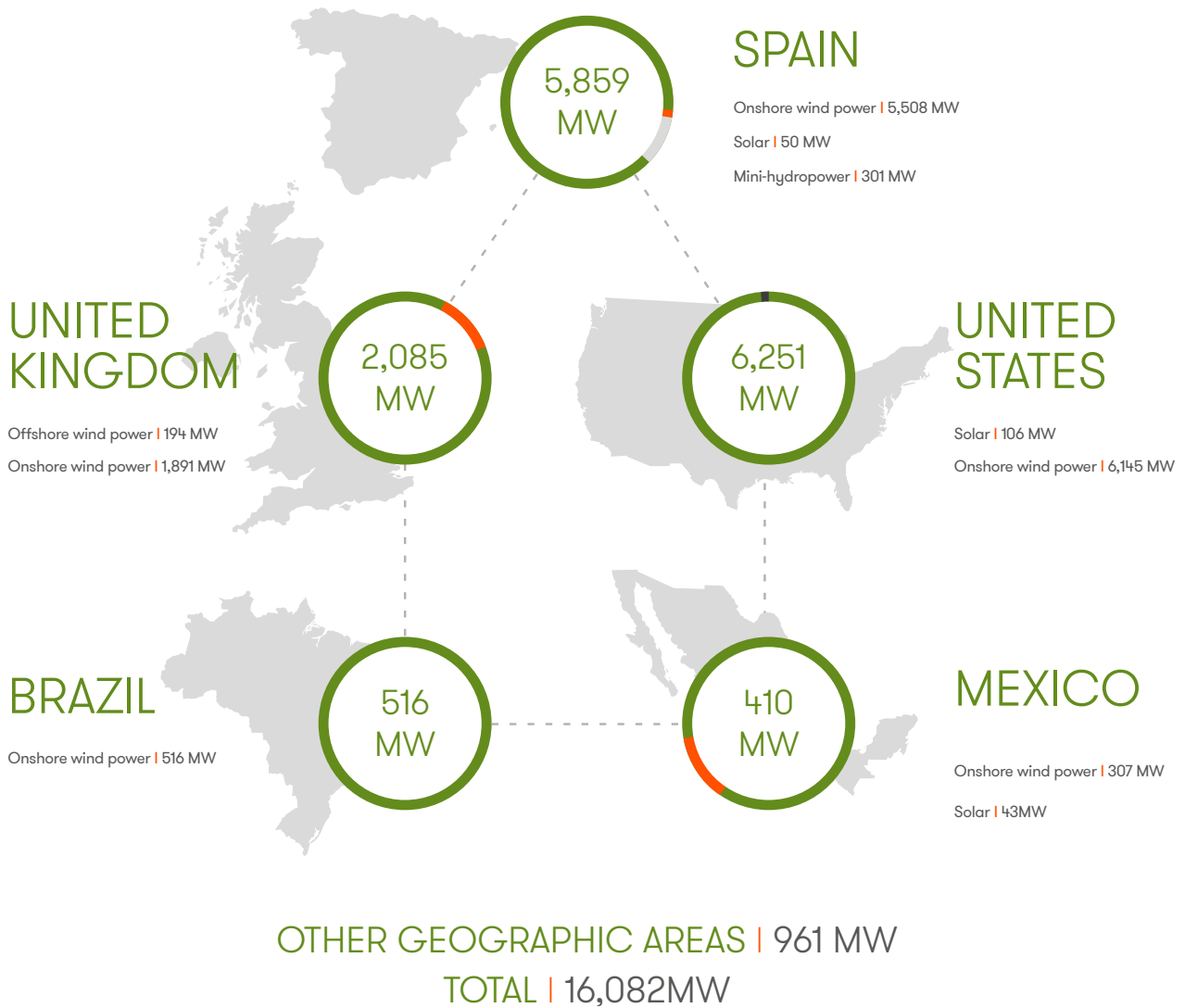

Energy Resource Prediction

The HPC4E Project

High-performance computing applied to wind energy

The objective of the HPC4E project is to apply new exascale supercomputing techniques to wind farm design. Exascale, the near future in computing, uses computing systems capable of making a minimum of 10¹⁸ operations per second, a thousand times faster than current supercomputers. This increase in speed will allow more complex problems to be solved with more efficient use of resources.

Wind farm designs are usually based on high-resolution wind models. With exascale, simulations using Large Eddy Simulator (LES) models may soon become the industry standard. LES models have higher time and spatial resolution than current RANS equations making them currently too expensive to be used as everyday tools. The LES models are capable of offering more precise wind field solutions and providing more information on key variables such as turbulence intensity. The benefits of exascale could also be applied to other weather models commonly used within the industry, such as mesoscale atmospheric models, which are used to diagnose and forecast wind production.

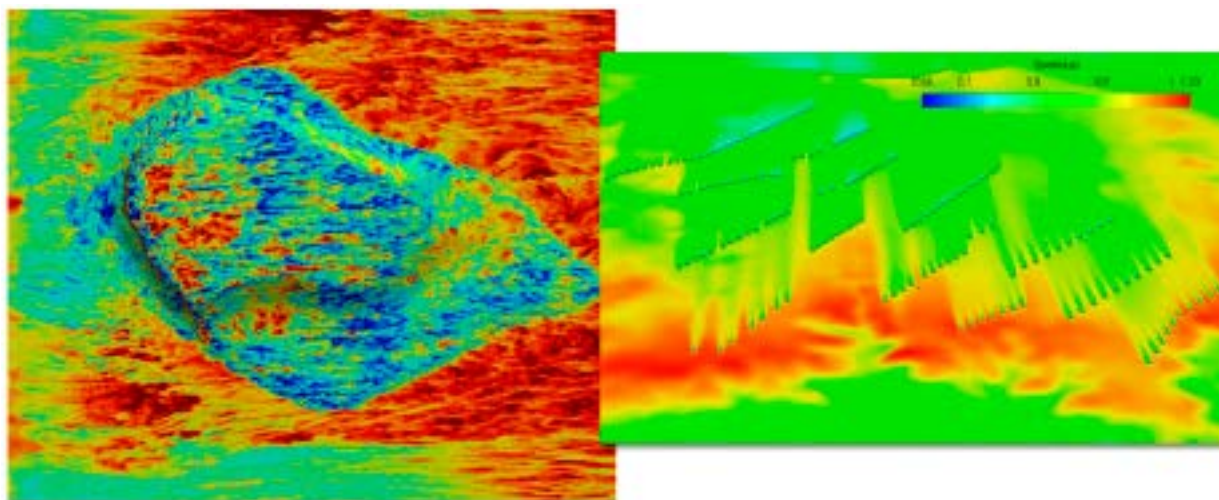

This project is part of the H2020 programme and has involved the Barcelona Super Computing Center (BSC), which Iberdrola frequently collaborates with, and CIEMAT. Brazil also collaborated in the project through institutions including the Centre for Renewable Energies at the University of Pernambuco (CER-UFPE) and the National Laboratory for Scientific Computing (LNCC).

Improving the efficiency of calculation systems

Iberdrola continues to improve its systems to analyse observations and design wind farms to be able to offer rapid, effective and precise answers when making decisions on new investments, as well as to reduce the risks due to uncertainty in estimates of future site production.

This task covers a wide range of actions. For some of these actions, we have worked in close collaboration with software suppliers to effectively integrate all developments and improvements to digital tools, streamlining design and analysis tasks. An example of this collaboration is the **Windographer software programme**, which includes an MCP calculation model to allow efficient and flexible analysis of meteorological tower observations.

In addition, an exhaustive analysis has been carried out on wind extremes in different locations. Calculating return periods for extreme wind speeds involves some uncertainty due to the inherent difficulty of characterising these periods with precision. In this project, a method has been developed which allows uncertainty to be determined, providing very useful additional information to the decision-making process, in particular on the risks of the site to the integrity of the turbines under extreme wind conditions.

Another of the projects developed aims to study the formation of ice on turbines. Ice causes health and safety issues, production losses, increased loads resulting in damage to equipment, and a reduction in the useful life of equipment, among other problems. However, there is a lot of disagreement among installers about production losses caused by ice and the responsibility for these losses, as well as issues related to guarantees. This project has developed a reliable method to calculate energy production losses due to the presence of ice, which can then be included internally in technical standards for energy studies conducted prior to the construction of facilities.

Improving the integration of renewable energies and energy storage

BEST PATHS

Beyond state of the art technologies for AC power corridors

The period 2016-2018 saw the completion of the **Best Paths** project, the biggest energy sector project included in the EU's Seventh Framework Programme for Research and Innovation. This project has brought together the best experts for five large-scale demonstrations which aim to develop new technologies to increase the transmission capacity of European electricity networks.

The demonstration led by Iberdrola served to investigate interactions between offshore wind farms and multi-terminal HVDC (high voltage direct current) converters, while at the same time identifying possible interoperability issues in order to increase electricity transmission performance. By reducing risks in this field it will be possible to increase the penetration of offshore wind energy into the European mix.

Iberdrola has led a group of industries and technology centres to create a scale simulator with three 60 kW modular converters with different technical specifications. The demonstrator is at the National Smart Grid Laboratory in Trondheim in Norway, which is operated jointly by SINTEF and the Norwegian University of Science and Technology.



SUBSYNCHRONOUS RESONANCE STUDIES

The laboratory created in the Best Paths project is being used to study the phenomenon of subsynchronous resonance. At connection nodes close to electronic power equipment such as STATCOM or HVDC converter stations, Iberdrola is experiencing subsynchronous resonance, which appears as a consequence of interactions between the controls for this equipment and wind farms.

The studies Iberdrola has carried out with Tecnalia in this laboratory have been used to develop algorithms to mitigate resonance. In the next phase, tests will be conducted with more complex topologies that are closer to the reality found at our facilities in order to better understand the causes of resonance and ensure that the damping algorithms are effective when put into practice.

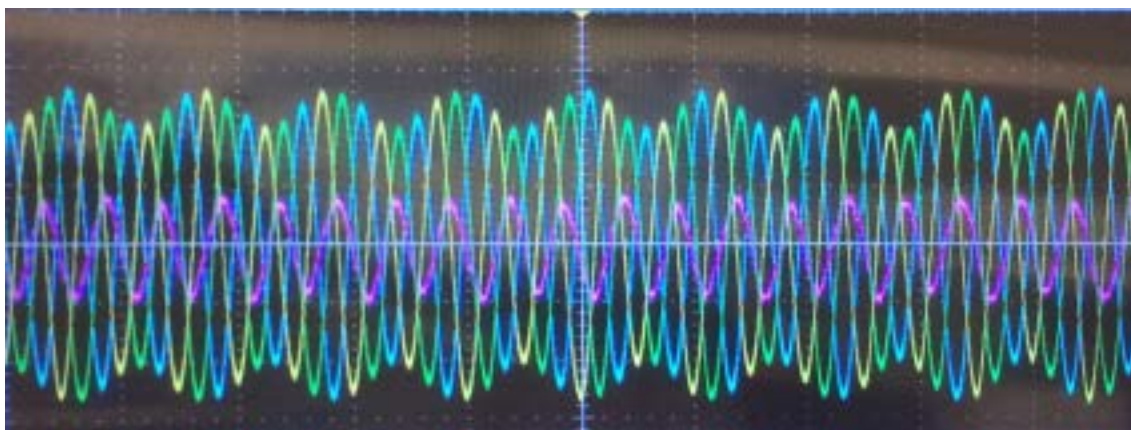

PROMOTION

Regulatory and financial framework for open-sea infrastructures

Promotion is currently the largest energy project within the EU Horizon 2020 research programme and its objective is to develop and demonstrate three key technologies: offshore diode rectifier converters, HVDC switches and protection for HVDC networks using equipment from more than one manufacturer. Also, a regulatory and financial framework will be developed for the coordinated planning, construction and operation of integrated offshore infrastructures, including a deployment plan for the future system of offshore networks in Europe.

Iberdrola has collaborated in this project by contributing its experience as an offshore wind farm operator and led the task of collecting experiences and lessons learned from companies that operate HVDC links in Europe, with the aim of extracting recommendations for future developments in links using this technology.

BALANCING AUTHORITY AND ENERGY STORAGE

In 2010, Avangrid Renewables was chosen to participate in the Bonneville Power Administration's Customer Supplied Generation Imbalance (CSGI) programme to forestall the rising costs of integrating wind energy into the BPA system. The CSGI programme allows Avangrid Renewables to meet its own Imbalance Reserve obligation, resulting in substantial cost savings. However, Avangrid Renewables will continue to remunerate BPA for its reserves regulation and provision activities, and is subject to its regulations as well as the regulations of its stakeholders.

In August 2018, Avangrid Renewables successfully passed the North American Electric Reliability Corporation (NERC) certification process and became an independent Balancing Authority (BA) with the task of balancing production and consumption in real time. The BA consists of 1,300 MW of Avangrid Renewables' wind generation located in the Columbia River Gorge and a combination of owned and contracted resources, hour-ahead capacity purchases and intra-hour energy purchases to balance wind production.

The BA certification will provide the following key benefits:

- Greater operational flexibility and access to a greater number of market structures that can only be used by BAs.
- Provide a competitive alternative to the wind energy integration rates established by BPA.
- Provide greater certainty about wind energy integration costs in the long term, allowing the company to provide its customers better service at a lower cost.
- Provide a platform for growth through services to customers, third parties and supply entities.

ENERGY STORAGE

The cost of storage is decreasing by the day, reflecting the pattern seen in the photovoltaic market. Many of these cost reductions are due to greater demand for other lithium battery applications (such as electric vehicles and mobile phones), which has led to technology efficiency gains.

Based on this premise, in recent years Iberdrola has been analysing battery technologies, particularly lithium ion batteries, with the aim of increasing knowledge of degradation, efficiency and electrical performance.

The first energy storage project to be installed will be in the Balancing Authority in the United States at the end of 2019. The 10 MW / 20 MWh lithium ion battery will be integrated into the BA as an additional asset to reduce balancing costs and improve operational flexibility.

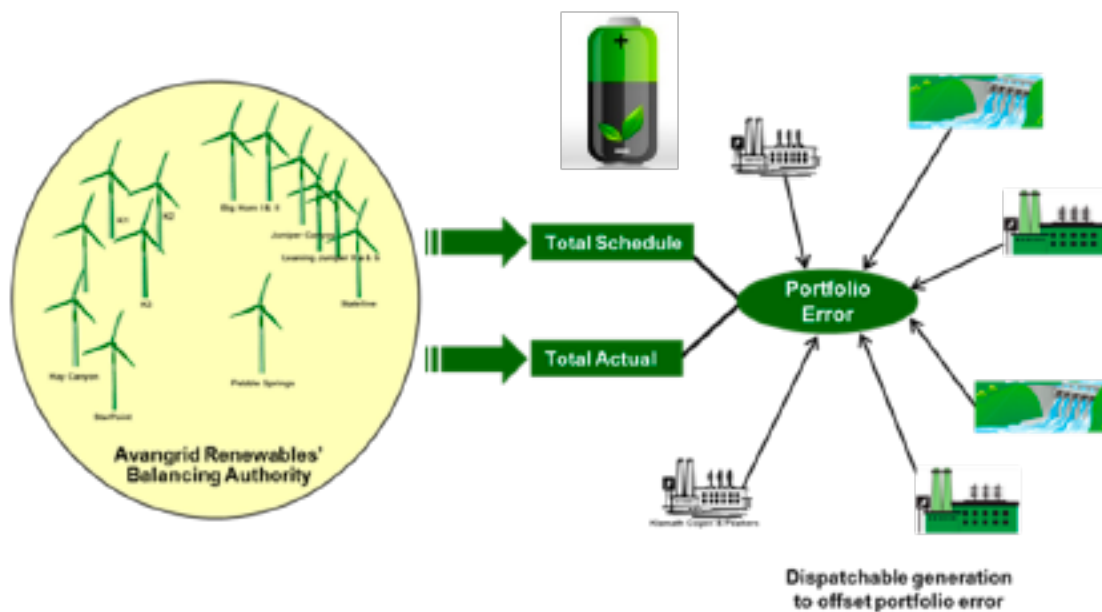

The following tools were developed in this period:

The ESS2WIND tool analyses energy storage systems associated with Iberdrola wind farms in Spain. This custom tool is capable of evaluating the size the battery system needs to be when operating in the Spanish market to provide various services, such as minimising imbalance and secondary frequency regulation. The Project allows different scenarios and sensitivities to be evaluated and in turn allows critical aspects to be identified with regard to the profitability of the asset.

ESS2GRID is a tool and method to determine battery size for operating in the fast/improved frequency response market in the United Kingdom. The application reproduces the requirements of the National Grid EFR tender, and is able to evaluate and select the best solution from among multiple alternatives and determine many results from a technical and economic point of view.

Storage in the United Kingdom

ScottishPower Renewables is analysing the placement of batteries in three locations in Scotland: Whitelee, Clachan Flats and Carland Cross. The financial model for the project is being developed by Everoze and the electricity model will be designed by TNEI. There has also been collaboration with multiple technology providers to ensure that all storage technologies are being considered.

SPR is also working with industry partners through the Carbon Trust Energy Systems Innovation Platform (ESIP). The objective is to gain a deeper understanding of how storage technologies can be operated to provide benefits to the UK electricity grid while offering a profitable business case. Crucially, ESIP will help the industry to overcome barriers which are hindering investment in solutions which give the electricity system greater flexibility.

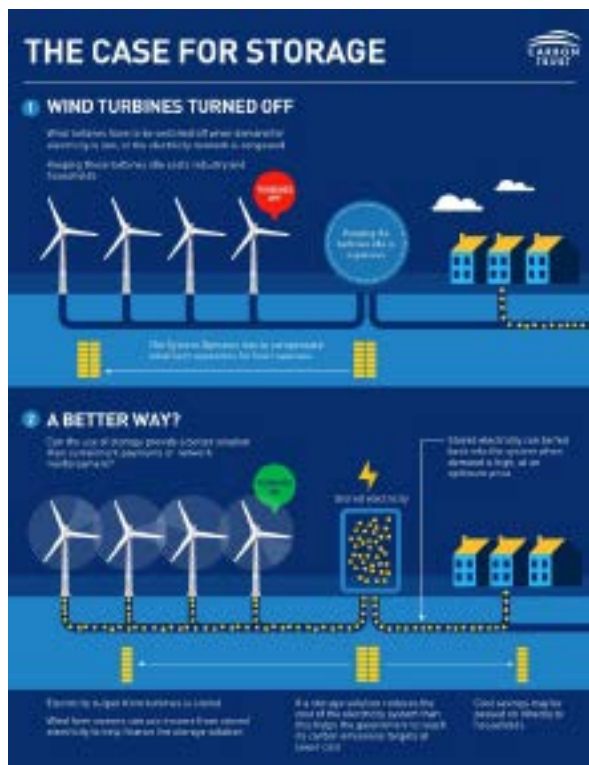

How storage technologies can help the UK electricity system (Source: The Carbon Trust's website)

SPR Futures

Futures, an internal ScottishPower Renewables initiative, allows employees to explore future opportunities for the business. The group was originally structured around technology areas; however ideas and resources were later combined and used to carry out sprint projects. These are used to evaluate the feasibility of the ideas presented to decide whether to devote more research to them. Some of the main ideas include:

- Adaptation of advanced conversion technologies (ACTs) in strategic sites for ScottishPower.
- Solar projects for self-consumption through SPR control centres.
- Charging points for electric vehicles (EV) using renewable energy



ScottishPower electric vehicles at Whitelee Wind Farm (Source: ScottishPower Renewables website)

Improved efficiency

Efficiency improvement is aimed at reducing operation and maintenance costs, and boosting production at our operational assets.

ENERGY THRUST

Turbine power curve optimisation

This project, carried out in collaboration with GAMESA, aims to improve G8× turbine production by optimising the power curve. Such improvements are focused on four aspects of the wind turbine's operating mode:

- Optimisation of its alignment.
- Optimisation of low-wind blade angle control.
- Optimisation of moderate-wind power curve control.
- Extra power in high-wind range.

The project has been deployed in approximately 1,100 turbines, certifying production increases without affecting the useful life of the turbines.

DARWIND

Data Analysis of Reliability in WINDfarms

DARWIND is a tool designed for decision-making in asset management. In 2016-2017, new statistical and data mining techniques were applied to detect faults and estimate costs, allowing Iberdrola to improve the drafting of its O&M budget as well as the negotiation of new O&M agreements for all of its wind farms. These improvements were focused on:

- Increasing the efficiency of estimates.
- Transferring knowledge between business units.
- Optimising purchasing, repair and storage strategies.
- Monitoring the performance of independent service providers.

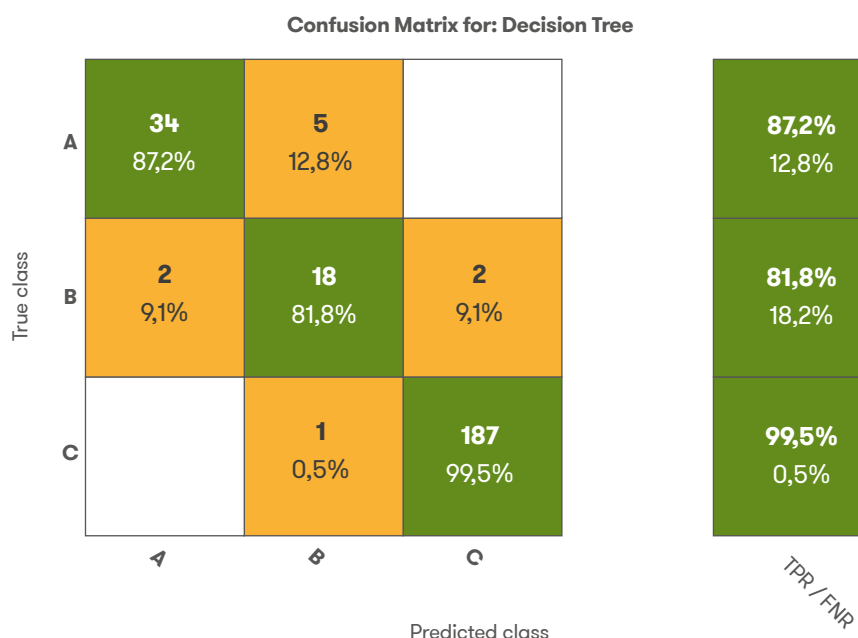

OLEO and MINEROIL projects

Extending the service life of oils

The project's main objective is to increase knowledge on the behaviour, properties and useful life of the mineral and synthetic oils used to lubricate wind turbine multipliers, with the aim of extending their useful life without diminishing their features or compromising equipment.

The project translates into reduced operations and maintenance costs, as well as reducing the amount of waste generated. The studies were conducted on different multiplier and wind turbine models, under different climatic and operating conditions as well as using different brands of oils.

Life extension project

One of the main lines of actions in this period is to extend the life of turbines, while guaranteeing their reliability and efficiency.

With this objective in mind, multiple studies and activities are being carried out to analyse the maintenance, inspection, repair and replacement needs of equipment to give them a useful lifetime of 40 years. These include load calculation studies to identify critical structural components in turbines and their foundations.

For turbine models with a large number of machines in the fleet, "fleet leaders" have been identified, which are subject to greater fatigue loading. Additionally, the required preventive maintenance activities are being analysed and possible reinforcements or design modifications are being studied aimed at extending useful life. This study will be conducted for each model of turbine in the Iberdrola fleet.

Arachnocopter project

Using drones to inspect wind turbine blades

This collaboration with the company Arborea Intellbird, which is partly owned by Iberdrola, has allowed significant progress in blade inspection tasks, thanks to a combination of the experience of Iberdrola's technicians, the inspection capacities of the drones and the tools that process the data collected during the inspections.

During this period, more than 700 blades have been inspected, allowing those most at risk of failure to be identified. This has allowed corrective actions to be carried out at very early stages, avoiding the high costs of fixing the blade if it were to fail completely.



Machinery control version comparison project

Wind turbine control systems are evolving towards maximising the production of active power and reducing the loads supported by components.

To to this, manufacturers are implementing new control strategies which meet both of these objectives. Iberdrola Renewables is monitoring these new control versions to analyse whether they meet these objectives.

It has designed a global monitoring system for a 2-MW G80 turbine with the aim of monitoring control strategies and the impact they have on the wind turbine. This monitoring system comprises an industrial computer that captures signals from the wind turbine control system and the various sensors placed by Iberdrola Renewables (extensiometric gauges, accelerometers and Lidar) on the nacelle, blades, shaft, frame and tower. The data are collected and stored in real time, providing the information necessary to analyse the behaviour of the turbine under these new strategies. This will give Iberdrola Renewables more data in order to be able to accept or reject the control versions provided by manufacturers, with the aim of preserving the asset.

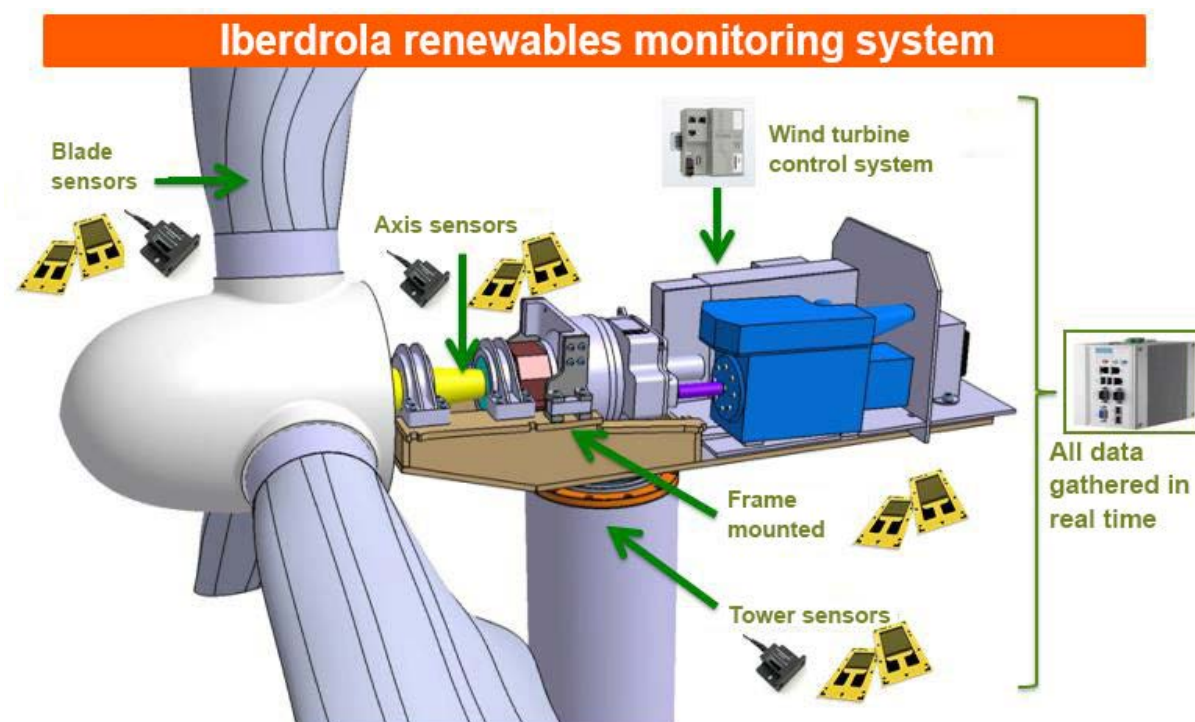

Portable gearbox oil filtering system

The majority of wind turbines in the Avangrid fleet have gearboxes to increase their speed which use severe-duty synthetic gear oil. Oil performance is a critical factor which affects the useful life of the gearbox. Therefore, the oil in each gearbox is analysed each year and the main parameters are studied. Cleanliness is one of the main variables to be controlled, as this can be affected by the presence of iron, steel, copper and brass from gears and bearings. Dirt and other non-metallic debris can also contaminate the oil.

All the gearboxes have an oil pressure pump and a filtration system. Usually, this filtration system reduces metallic and non-metallic contamination to levels which do not significantly affect the operational life of the gearbox. However, in many cases, non-metallic material is filtered and can exceed the limits at which we have determined to be detrimental to the gearbox.

In an effort to extend the useful life of gearbox oil, the first portable, high-capacity gearbox oil has been developed in collaboration with various experts. During maintenance tasks, technicians will place the cart in the gearbox, where it will remain for a time while the turbine is in operation. The cart will have a wireless transmitter which will send up-to-date data on oil cleanliness to the technician's PC. Once the desired level of cleanliness is reached, the cart will be placed in another turbine. The samples taken will determine when the next filtration will take place.

One pre-production unit has already been trialled in Minnesota and 7 production units are currently being built, which will be delivered to wind farms in the Midwest.



ASPA Project

Advance System for Predictive Analysis

In 2017, work began to develop a new predictive monitoring system for wind farms, called ASPA. The project's pilot phase covers three onshore wind farms, Doña Benita (ESP), Big Horn I (USA) and Arecleoch (UK), as well as the Wikingen offshore wind farm. The new system is based on expert multivariate statistical analysis using machine learning and big data techniques to generate digital models which simulate the physical functioning of the principal wind turbine systems (rotor, multiplier, generator, converter and transformer). Once the development phase of the project has been finalised, it will be put into operation for validation by the Renewables O&M units.

The main objective of predictive maintenance systems is to detect faults in the main components of wind assets in their early stages. Innovative predictive maintenance systems allow corrective actions such as optimised scheduling of O&M activities and energy production, and lower corrective maintenance costs. Predictive tools are essential when it comes to offshore technology due to the higher maintenance costs associated with offshore assets.

Equipment deterioration curve:

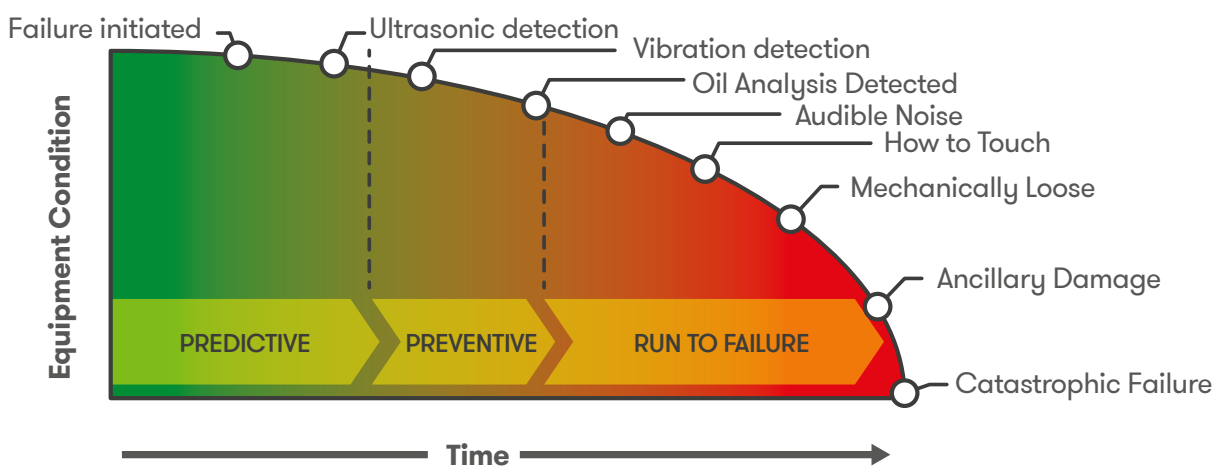

DOMINA Project

Tool for comprehensive management of renewable assets

DOMINA is Iberdrola's corporate asset management tool for its renewable assets. The tool originated in Spain in 2005 and was designed in response to the need to implement an operating model in wind farms. The aim was to develop a tool to manage Operations and Maintenance activities while at the same time ensuring the standardisation of these processes in wind farm assets.

In 2010, the tool began to be implemented in business areas outside Spain, and it is now in operation in the USA, the UK, Mexico, Brazil, Greece and Portugal. In addition, the tool's functionalities have been extended year after year to give it more versatility and capacity in the search for operational efficiency. Since 2016, efforts have been focused on improving the work order fulfilment process in SAP. Currently, various lines of action are being launched with the aim of streamlining the fields to be filled in for each work order, automating certain validation processes which are currently completed manually and developing a user-friendly interface to simplify the completion of information.

DOMINA has been implemented in all of Iberdrola Renewables' facilities, including onshore and offshore wind, mini hydraulics, thermosolar and photovoltaic technologies, corresponding to approximately 17 GW of installed capacity.

It is a key tool for the company and its operating model, which is based on ensuring the maximum useful life of its facilities and maximising knowledge of technology. Its purpose is to maximise operating efficiency, unifying and standardising the ways of working and the management of assets in the different units of the Iberdrola Renewables Business.

METEOFLOW Project

A comprehensive system for forecasting meteorological variables

Meteoflow is a comprehensive system for predicting medium and long-term meteorological variables at the different national and international sites for wind farms and solar plants.

The project came about in 2004 in response to a need for production forecasts in order to participate in the Spanish electricity spot market.

The system has since been under constant development, responding to the company's new requirements. The current objectives of the project are to meet the requirements of the different energy retail markets in which Iberdrola facilities participate and support the scheduling of their Operations and Maintenance tasks with minimal impact on production.

The key work undertaken in the past two years includes:

- Incorporation of the PV power forecast.
- Installation and configuration of an ocean wave model to increase meteorological information for offshore wind farms.
- Use of new machine learning techniques to improve existing models.
- Development of a smart database to improve efficiency and quality of model readjustments.

Technology Innovation Centre (TIC)

TIC activities

The Low Carbon Power & Energy programme (LCPE) is run by the University of Strathclyde Technology & Innovation Centre (TIC) and consists of both industrial and academic partners working together. Since its creation in 2013, the programme has identified and carried out research projects within the energy sector, mainly related to low-carbon energy emissions: wind energy (onshore and offshore), hydroelectric management and network management.

The collaborative partners include ScottishPower, Scottish & Southern Energy, the University of Strathclyde and Wood. Initially, the collaboration projects were categorised into asset management, electrical systems and foundations and installations. This has now evolved and the following high-impact projects have been carried out:

- a. Wind turbine ancillary services.
- b. Improved wind and hydraulic prediction tools.
- c. Simulation of offshore wind farm logistics and installation.

Offshore wind power

Projects involving offshore wind farms

In recent years the company has positioned itself as a world leader in offshore wind, which is one of the company's key vectors for the 2018-2022 period. In this period, selective growth is expected in 3 main areas (Baltic, East Anglia and the East Coast of the United States) based on a solid project portfolio of 7.5 GW, consolidating offshore wind as a key business for Iberdrola.

These are the main projects in this area:

- West of Duddon Sands, (North Sea, 389 MW): The project, which has been in commercial operation since October 2014, has been jointly undertaken by Iberdrola (through ScottishPower Renewables) and the Danish company Ørsted. It has 108 3.6-MW Siemens turbines installed on single-pile foundations approximately 20 km from the coast at a depth of 20 m.
- Wikinger (Baltic Sea, 350 MW): The Wikinger wind farm in Germany was connected to the grid in December 2017. It consists of 70 5-MW Adwen turbines installed on 4-legged jacket foundations approximately 75km offshore at a depth of 40m.
- East Anglia One (North Sea, 714 MW): This wind farm in the UK has 102 7-MW Siemens turbines installed on 3-legged jacket foundations and is located some 45 km offshore at a depth of 40 m. This wind farm is currently under construction.
- Saint-Brieuc (Côtes-d'Armor - France): wind farm in consortium with Eole RES (70% Iberdrola), with a capacity of 496 MW, located approximately 35 km offshore at a depth of 40 m. Connection to the grid is scheduled for 2023.
- Vineyard Wind (Massachusetts): Iberdrola, through its subsidiary Avangrid Renewables, in consortium with CIP (50%) is participating in the development of an offshore wind farm located approximately 55 km off the coast of Cape Cod in Massachusetts. This approximately 800-MW project is expected to enter into operation in 2021.

Innovation in offshore wind power projects is fundamental to reducing investment and operations and maintenance costs and limiting the risks in projects. Within this general approach, below we highlight some of the activities carried out in our project portfolio:

Wikinger:

- Design, construction and installation of the 4-legged jacket foundation to be built by Bladt and Navantia. The design of the foundation has been adapted to the site, and optimised to simplify the fabrication process.

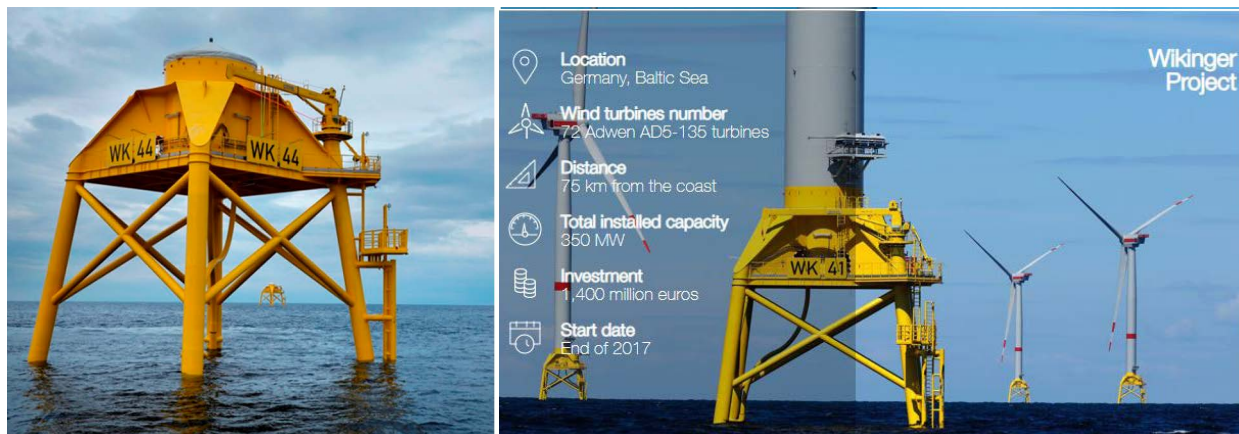

Jacket foundation

- Innovative design of the offshore substation for the Wikinger wind farm that involves building it in two modules due to weight and size restrictions for transportation and installation, along with its foundations on a 6-leg jacket structure. The foundations will be built by Navantia.



3D design of the Wikinger wind farm

- In addition, it is worth noting the highly innovative nature of other elements of the wind farm, such as the 5-MW Adwen turbine and the connection cables between the wind turbines and the 33-kV substation.

East Anglia One:

- Design, construction and installation of the 3-legged jacket foundation to be built by Lamprell and Navantia. This innovative design has led to significant cost savings.



3-legged jacket foundation

- Siemens-Gamesa is currently building the 7-MW turbine.
- Another innovation milestone was the selection of the pioneering 66-kV array cable between the turbines and the offshore substation, built by JDR.
- Finally, we have committed to setting up a test area to carry out projects and trials, allowing us to adopt cutting-edge technologies and reduce the costs of our growing project portfolio. Currently, two projects, funded by Innovate UK, have been launched: Crown 2 aims to analyse new anti-corrosion protection systems based on the application of an aluminium spray and validate an alternative scour protection system installed in suction caisson foundations.

Saint-Brieuc:

- One of the challenges of this project lies in the seabed: its peculiar characteristics have led to innovative onshore pile testing being conducted.

OWA: Offshore Wind Accelerator

OWA is an initiative led by the British organisation The Carbon Trust with the world's biggest offshore wind farm developers as partners (Ørsted, Equinor, Shell, SSE, ENBW, Vattenfall, E.On, Innogy and Iberdrola through Scottish Power Renewables). The primary goal is to reduce the cost of offshore wind power technology.

To ensure that the activities are conducted properly, the initiative builds upon projects of common interest to all the promoters, in which general issues are addressed, as well as discretionary projects aimed at fostering the development of new designs, procedures or standards. In all cases, the proposals are prioritised, identifying those with the greatest potential for cost savings. In addition, they try to involve the entire supply chain, with special support for possible innovations of interest so they can achieve a market position.

The initiative is based on four main thematic activities as described below:

- **Wakes:** This area includes all initiatives aimed at improving production estimates and optimising the design of wind farms through a better understanding of the energy resource, thereby reducing the cost of such facilities. Great effort is being made to model the wake effect on wind farms caused by interaction between the wind and the turbines. The activities carried out include: validating the power and efficiency curve and measuring the pressure curve, reducing the uncertainty around Lidar, using Lidar to evaluate offshore sites, defining boundary conditions for measuring atmospheric stability, and analysing the effects of coastal phenomena.

As regards measuring real atmospheric conditions at wind farms, special mention should be given to the project called Floating LiDAR, in which different floating lidar (measuring the wind by emitting laser beams, Light Detection and Ranging, mounted on buoys) that will lower the cost of measurement campaigns at sea compared to the traditional use of weather towers. Furthermore, the models currently in use will benefit from the measurements obtained through this technology, allowing improved production calculations. The main goal is to validate this sort of technology at different sites to replace the current technology.



Floating lidar vs met mast (source: Scottish Power website)

- **Access:** This working group closely monitors all new developments regarding access systems and vessels, planning models for O&M strategy, as well as reviewing regulations and anything related to offshore wind farm accessibility. In particular, funding has been made available to companies with new designs to demonstrate their concepts by means of numerical models, tank testing and prototype construction. Support is also continuing to be given to new ideas for ships, transfer systems and improvements to ship berthing safety. Studies are also being carried out to improve understanding of the ships used to transport maintenance personnel and platform access systems.



Offshore wind farm access boats (Source: The Carbon Trust)

- **Electrical systems and cables:**

The studies carried out mainly focus on improving the efficiency and reliability of offshore wind power electrical systems, with projects aimed primarily at raising generation voltage to 66 kV, thus aiding commercial development throughout the supply chain. These studies include the testing and certification of four XLPE interarray cables at this voltage, which is currently one of the elements that most restrict the implementation of 66 kV. In this regard, the installation of a 66-kV transformer on the transition piece has been studied, with the aim of reducing costs.

Various studies have also been conducted to optimise transmission systems, including studies to optimise direct current substations (HVDC) by combining AC and DC substations; analysis of a new proposal for an HVDC system encapsulating diode rectifier technology (a solution put forward by Siemens); and analysis of low-frequency AC links as an alternative to DC power transmission.

Additionally, various studies have been carried out associated with the laying of undersea cables, with the aim of reducing installation costs and failure rates. In this regard, a methodology has been developed for burying the cables, thus reducing the associated costs. Several cable protection systems have been analysed as well as various alternatives associated with cable performance in dynamic environments that would lead to cost savings, as well as improvements to the installation process, and reduced operation and maintenance requirements.

For its part, the DTR (Dynamic Thermal Rating) project aims to optimise the export cable based on the thermal parameters under operating conditions.

Another pillar of the investigation has been improving the activity monitoring system to reduce and detect faults throughout the useful life of the cable.

Finally, research is being undertaken into black start turbine systems, which can power turbines when there is no connection to the grid in order to feed auxiliary systems. Diesel generators have been traditionally used for this purpose in the industry, but they are costly and polluting.

Foundations: The main objective of this activity is to reduce the costs associated with foundations, in terms of both initial investment as well as their maintenance and service life. To do this, several studies have been undertaken aimed at maximising the useful life of foundations and diverse strategies have been established for monitoring them. There have also been studies on existing underwater inspection techniques, corrosion protection systems based on impressed currents, and corrosion and fatigue analysis. In the same vein, existing designs continue to be optimised through projects such as PISA II, which aims to extend the application of XL monopiles to more complicated locations; GOAL, which aims to develop guides for the application of ordinary Portland-type cement to cemented joints, thereby reduc-

ing costs and technology risks; Vibro, which uses analysis of partial safety factors used in the design of impact or vibratory driven piles to reduce installation costs, and JaCo, which aims to reduce the cost and extend the useful life of jackets.

Additionally, and as a critical element of activities in this area, continued support is being given to the development of innovative foundation solutions, with the creation of design guides for suction buckets, as well as improvements to the design of monopiles.



Suction bucket jacket foundation (Source: Ørsted website)



Monobucket foundations (Source: Universal Foundation website)

USA NATIONAL OFFSHORE WIND RESEARCH AND DEVELOPMENT CONSORTIUM:

In June 2018, the New York State Energy and Research Development Authority (NYSERDA) was given \$18.5 million by the United States Department of Energy (DOE) to lead the national research and development consortium. The consortium is growing and expanding on New York's work to advance in the effective and responsible development of offshore wind power through collaboration between the offshore wind industry, public services, research laboratories and other states. The DOE award, matched by NYSERDA, is being used to establish an independent partnership that is market-driven and industry-led to develop the disruptive technology needed to make offshore wind energy an even bigger economic driver for coastal states and a clean source of renewable energy for the nation. The National Offshore Wind Research and Development Consortium is the first federally funded private-public partnership focused on advancing research and development to accelerate the offshore wind industry in the United States.

The Consortium's Board of Directors is structured to include offshore wind industry leaders, states, US representatives of national utilities and national laboratories. The members of the board include representatives of industry leaders, the Advanced Energy Research and Technology Center (AERTC) at New York State University at Stony Brook; The Carbon Trust International, Inc.; National Grid; NYSERDA; Renewables Consulting Group and US national laboratories as well as offshore wind developers Avangrid Renewables; Deepwater Wind; EDF Renewable Energy; EDP Renewables; Equinor; Innogy; Northland Power; Ørsted; and Shell. Building on successful European models, the Consortium is engaging private sector support that will allow it to chart a path to financial self-sufficiency, so it can continue its work well beyond the initial four-year federal award period.

In November, the Consortium announced the launch of its first Research and Development Roadmap to advance offshore wind technology, drive wind innovation and combat climate change. The Roadmap establishes a long-term vision for innovative offshore wind technology development in the United States and identifies key priorities for establishing the industry as a national leading clean energy sector.

The Consortium, headquartered at the AERTC, will prioritise, support and promote the adoption of offshore wind technologies as well as supporting US-based manufacturing and the offshore wind supply chain. Public and private partners have been enlisted to support consortium initiatives that will specifically focus on driving further cost reductions for offshore wind development, lowering the deployment risk to investors, and expanding the range of feasible project sites in each of the five US offshore regions. As such, the Consortium will fund research and development initiatives that focus on three pillars:

1. Offshore wind plant technology advancement: will include research and development opportunities that focus on addressing near-term and mid-term challenges to reducing development costs in the initial phases of US offshore wind projects.
2. Offshore wind power resource and physical site characterisation: aims to reduce the risks associated with offshore wind in the United States through research and development that focus on activities that lower the cost, time, and uncertainty in site characterisation for offshore wind developers on the US Outer Continental Shelf (OCS).
3. Installation, operations and maintenance, and supply chain: will focus on research and development activities that lower the costs and time for US offshore wind project construction, installation, and operation and maintenance.

Focusing on the research and development priorities identified in the Roadmap, the Consortium intends to distribute available research funds through a series of open solicitations over the next four years. The first request for proposals under the Roadmap is expected to be announced in 2019.

ORE - CATAPULT:

In collaboration with consultants ORE Catapult, the Offshore Wind Innovation Council (OWIC) has been established to set out a series of challenges to be resolved by the industry and which could be validated in ORE Catapult facilities. We are also continuing our participation in 2 other projects:

SPARTA Project:

Iberdrola participates in the collaborative SPARTA (System Performance, Availability and Reliability Trend Analysis) project, managed by the Offshore Renewable Energy Catapult in the UK. This project is aimed at detecting opportunities to improve wind turbine operating efficiency, as well as analysing wind turbine availability and failure rates based on information provided (anonymously) by different wind farm developers, which will allow operational cost savings and boost production.

BLEEP Project

- BLEEP is an industrial joint venture between offshore wind farm owners and operators in the United Kingdom. The Offshore Renewable Energy (ORE) Catapult has identified erosion as a key issue for offshore wind power operators and manages BLEEP on behalf of the project partners to tackle this problem through blade repair measurement campaigns and research into corrective solutions.
- BLEEP has three complementary projects within the programme which consist of conducting measurement campaigns in the project partners' wind farms. These are aimed at characterising the effect of erosion on key performance indicators, principally energy production, as well as developing repair and elimination procedures to extend the useful life of wind turbines.
 - **BLEEP Project 1:** Lidar measurement campaign to evaluate the impact on energy performance
 - **BLEEP Project 2:** Evaluation of the performance of a wind turbine following repair of the blade in comparison with the performance of an adjacent turbine
 - **BLEEP Project 3:** Evaluation of the effects of erosion to characterise blade leading edge erosion in different operating conditions



Leading edge erosion on a wind turbine blade [Source: North America Clean Energy website]

R&D projects associated with offshore wind generation.

Additionally, Iberdrola is working on the following R&D projects associated with offshore wind generation:

ROMEO (Reliable OM decision tools and strategies for High LCoE reduction on Offshore Wind):



Iberdrola Renewables is leading the ROMEO project, financed by the European Union under the Horizon 2020 programme. A total of 12 European companies and research centres are participating in the project, which began in June 2017 and will last 5 years.

The main objective of the project is to reduce the operations and maintenance costs of offshore wind farms using advanced monitoring models, tools and strategies to move away from corrective/preventive maintenance toward condition-based maintenance. This transition will increase reliability, reduce turbine stoppage times, and may reduce the number of inspections that need to be undertaken on substructures.

Additionally, a flexible analytic platform based on the cloud and internet of things will be developed, as well as a platform for the management of operations and maintenance information, aimed at improving the decision-making process. Finally, advanced monitoring systems will be developed for the principal turbine components, as well as low-cost structural monitoring systems.



The developments of this project will be tested at the Wikingen (Germany) and East Anglia One (UK) wind farms.

LEANWIND project (Logistic Efficiencies And Naval Architecture for Wind Installations with Novel Developments):



Iberdrola Renewables Energy and Iberdrola Engineering and Construction have participated in the LEANWIND project, financed by the European Union as part of the Seventh Framework Programme. A total of 31 companies and universities/research centres have taken part in the project, which began in December 2013.

The overarching aim of LEANWIND is to reduce costs throughout the life cycle of an offshore wind farm by applying LEAN principals and developing technologies and tools that contribute to this objective, including: foundations (fixed and floating), installation and maintenance boats, optimisation of operations and maintenance tasks, design of digital planning tools, logistics and costs, etc.

Within the framework of this project, Iberdrola has developed the basic engineering for a floating semi-submersible platform, validating the design by conducting tests in the canal at University College Cork (UCC).



Tests were also conducted to validate operations and maintenance activity simulation tools.

Scour Protection Jacket (SPJ) and HaSPro projects.

Iberdrola Renewables has participated in the SPJ project, partially funded by the Regional Development Society of Cantabria (SODERCAN)'s I+C=+C 2016 programme to support R&D in cooperation in offshore renewable energies. The project consists of studying the effects of scour on jacket-type structures and optimising anti-scour systems.

In the project, which has a duration of 2 years, a method to calculate strain on jacket-type structures when submitted to hydrodynamic loads and scour due to wave action, currents and sand waves has been developed in collaboration with Ingecid. By applying this method, a structural analysis was undertaken of the whole wind turbine and the elements supporting it in order to analyse the effects of scour on the specific substructure. From this, conclusions were obtained on time periods for carrying out actions to correct scour, based on the levels at which it occurs and the design of the structure.

Also, traditional scour protection systems (using rock) were analysed in comparison with innovative alternatives using artificial materials (frond mats). To validate the behaviour and stability of both protection systems, scale tests were undertaken at the canal at the facilities of the Environmental Hydraulics Institute in Cantabria.

The results of the project will optimise offshore wind farm design, installation and maintenance costs.

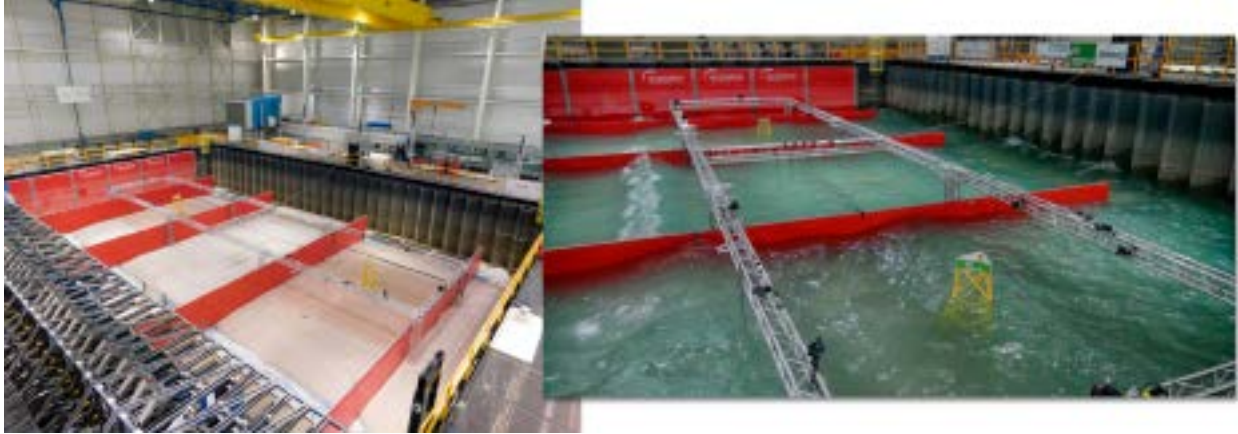

Scottish Power Renewables participates in JIP HaSPro, a collaborative project led by DeltaRES which aims to develop a method and design guide for scour protection systems for offshore foundations. During the project, different types of scour protection will be tested as well as different installation methods.

Lifes50+ project (Qualification of innovative floating substructures for 10 MW wind turbines and water depths greater than 50 m)



The objective of the project is twofold: firstly, to qualify and optimise two structural solutions for floating foundations for 10 MW generators. The chosen concepts will be taken from an existing list of 4 candidates, which will be developed and evaluated using uniform criteria, using a 10 MW turbine model as a reference. IBERDROLA Engineering and Construction is the designer of one of these 4 candidate concepts. The second, more general objective is to develop a KPI-based methodology for any design and qualification process for these types of solutions focusing on technical, economical, and industrial aspects.

The project is being led by SINTEF OCEAN and involves 12 partners from 7 countries, including research centres, solutions designers and certification bodies. Iberdrola Engineering has participated both in designing the solutions to be tested and in developing digital validation models, risk methodology, economic valuation, manufacturability and other aspects forming part of the evaluation method.

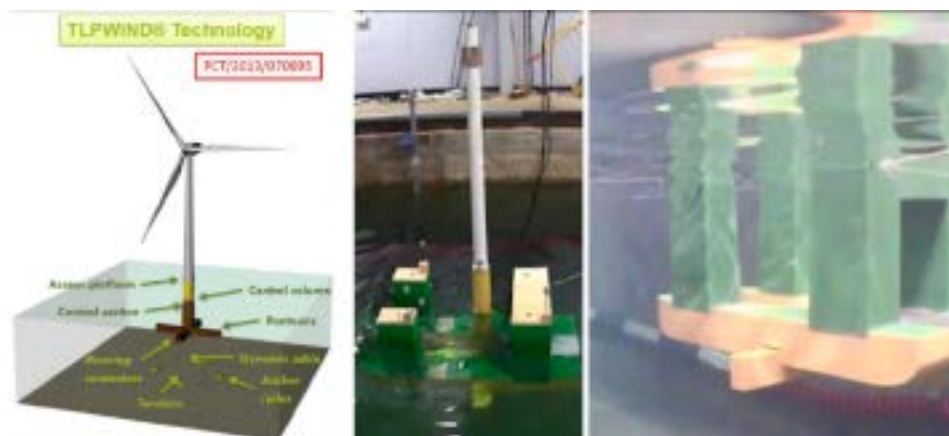

Flow Project

The main objective of the FLOW project is to develop a floating wind turbine for future experimental validation in order to develop offshore wind energy in shallow-water areas, in a way similar to how this sector is developing in shallow waters in the North and Baltic seas.

The following specific goals have been defined to achieve the FLOW project's main objective:

- Analysis of the turbine's mechanical, electrical and control adaptation needs.
- Design a floating structure adapted to the wind turbine along with the moorings and anchorings necessary to keep the turbine in position.
- Integrate the combined wind turbine-float unit and its validation at a reduced scale in a test canal.
- Detailed overall design including the necessary manufacture and installation information.
- Define and optimise prototype manufacturing processes, as well as assembly, launch, installation, operation, maintenance and dismantling procedures.
- Risk analysis of the technology and of the demonstration project.
- Design certification.

These objectives are aimed at reducing costs in the medium term in order to give floating offshore wind power an LCoE (Levelised Cost of Energy) and make it competitive with other renewable energy sources.

The project is being led by NAUTILUS FLOATING SOLUTIONS S.L. with the participation of Iberdrola Renewables, Astilleros Murueta, Nervión, Navacel, Vicinay Cadenas, Vicinay Sestao, CT Ingenieros, Clúster de Energía, Ormazabal OPA, NEM Solutions, Matz-Erreka, HWS, Uniport Bilbao and Foro Marítimo Vasco.

Operational Excellence in Hydraulics Technology

HIDRASENSE

New advanced air and steam detection technology in fluids at electricity generation power stations to efficiently manage energy resources

The HIDRASENSE project resulted in the development of an experimental system for detecting air bubbles (emulsification) and steam (cavitation) in fluids present at electricity generation stations, primarily thermal and hydroelectric power plants, through a photonic technique based on high-power lasers and wide-band photodetectors together with the required digital process. The project represents a very substantial step forward for the sector.

The specific objectives of this project were:

- Detecting real-time cavitation issues affecting the pipelines in the hydraulic facilities at electricity generation stations, thus precluding problems derived from such issues.
- Detecting cavitation in dam drainage systems, both spillways and background drainage, and preventing undesirable effects: structural damage to the spillway, wear and even partial or total destruction of the intake valve, among others.
- Developing an innovative management solution to reduce financial losses caused by unscheduled non-availabilities of thermal and hydroelectric power plants, and reduce the associated maintenance costs.
- Increasing the efficient use of the water resources used as the raw material for generating hydroelectric power.

The project was active until the end of 2017 and was deployed in the following stages:

- Theoretical study, requirements and specification of the system.
- Photonic sensor development.
- Design of the structure and installation in the plant.
- Characterisation in laboratory, calibration, validation and operating plan.

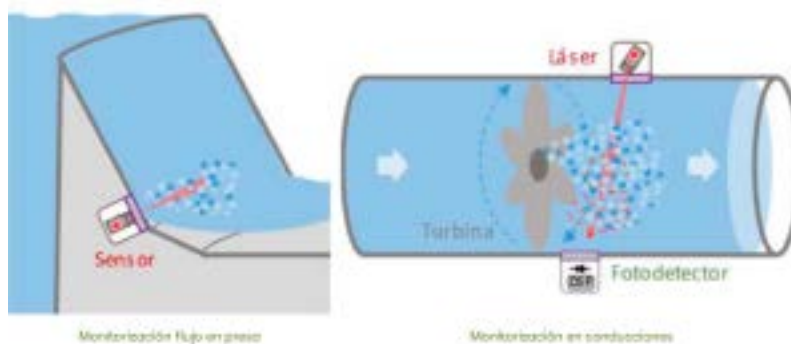

HYDRODEMAND

Advanced technologies for high-efficiency turbines

The overall objective of the project is to develop new technologies for Francis turbine generator sets to improve their hydraulic and mechanical behaviour at partial loads, increasing their flexibility and robustness. This will contribute to the integration of renewable energy into the energy mix and significantly increase the reliability, versatility, energy efficiency, safety and environment of the hydroelectric plants of the future.

To achieve this, the following specific objectives have been established:

- Obtain a new design for water turbines to maximise the amount of energy produced by the plant.
- Reduce the effects of fatigue, erosion and corrosion on turbines, which reduce the flexibility and safety of the system.
- Increase the performance and reliability of turbines while maintaining their efficiency.
- Generate knowledge to predictively detect performance losses and avoid unplanned maintenance.
- Control the level of deterioration of turbo generator sets.
- Develop new autolubricated mechanical elements which eliminate the risk of spills, protecting the environment.



HYDROSmart

Smart monitoring and control system for power plants

The aim of the project is to develop a new smart monitoring and control system for hydroelectric plants that allows advanced operation by incorporating new predictive maintenance and trend analysis techniques to contribute to optimal integration of renewable energy into the energy mix. This system will provide a significant increase to the safety of people, the electricity supply and the environment, as well as greater versatility in terms of generation and energy efficiency.

To achieve this, the following specific objectives have been established:

- Develop a new system to monitor, control and acquire data with advanced functions in relation to the cybersecurity of the critical infrastructures operated, the availability of facilities and the efficient management of the response to extreme emergency situations such as floods and earthquakes.

- Research and incorporate real-time hydrological information systems to improve the management of waterways and the safety of people the environment and facilities.
- Research the development of advanced technologies to improve communications in real time with other control centres and public bodies, facilitating information and civil protection tasks.
- Incorporate new rapid maintenance techniques based on secure, rapid remote access to various system servers to optimise their reliability and availability.
- Virtualise certain physical servers to improve their flexibility and speed and make them more efficient to use.
- Implement big data analysis techniques to improve operation by incorporating new predictive maintenance and trend analysis techniques.
- Develop a new smart system to improve the physical security of facilities and guarantee the connection of all elements with the central control centre so they can be remotely monitored, providing the system with devices to capture and send images of the dam water level and floodgates.

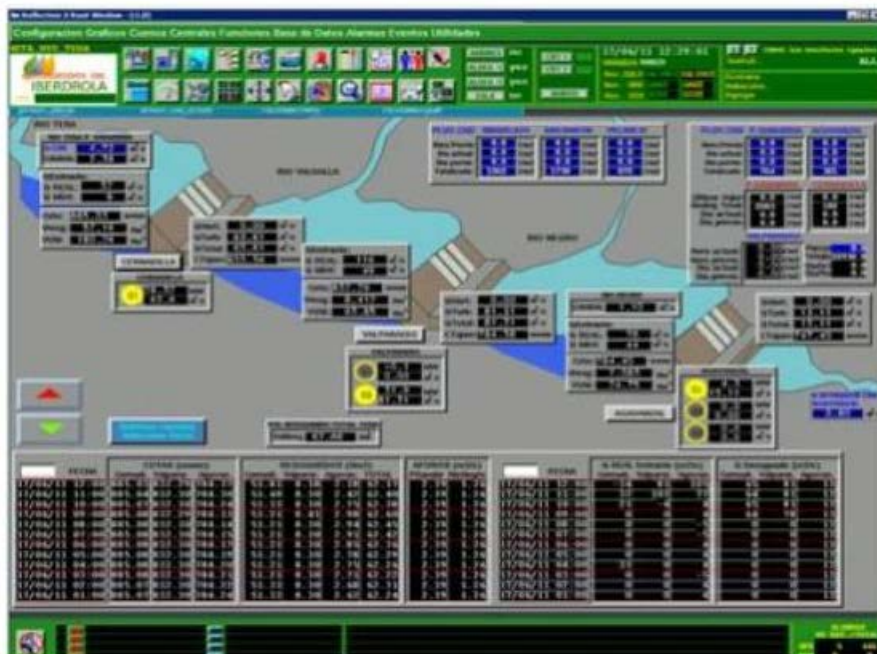

FILTRACIONES Project

Developing a simple and non-destructive method to detect possible leaks and structural anomalies in canals

In this project, a simple and non-destructive method has been developed to detect possible leaks and structural anomalies in canals in hydroelectric plants. The project lasted 18 months, had a budget of €720,000 and involved CEDEX and Geofísicas Consultores. During the project, thermographic studies were carried out using drones, as well as georadar tests, seismic methods and electrical tomography. Iberdrola is therefore improving both risk prevention and operational efficiency in the maintenance of its more than 180 km of canals.

Completed at the end of 2018, the project was deployed in the following stages:

- **STAGE I: ANALYSIS OF PREREQUISITES AND DEFINITION OF SPECIFICATIONS**
 - › Review of the state of the art of technology
 - › Analysis of boundary conditions and selection of canal sections
- **STAGE II: TESTING ON DIFFERENT CHANNEL SECTIONS**
 - › Developing the selected technologies
 - › Establishing a draft method
- **STAGE III: VALIDATION OF NEW CHANNEL INSPECTION METHODS**
 - › Final tests of the proposed draft method
 - › Analysis of results and technological feasibility

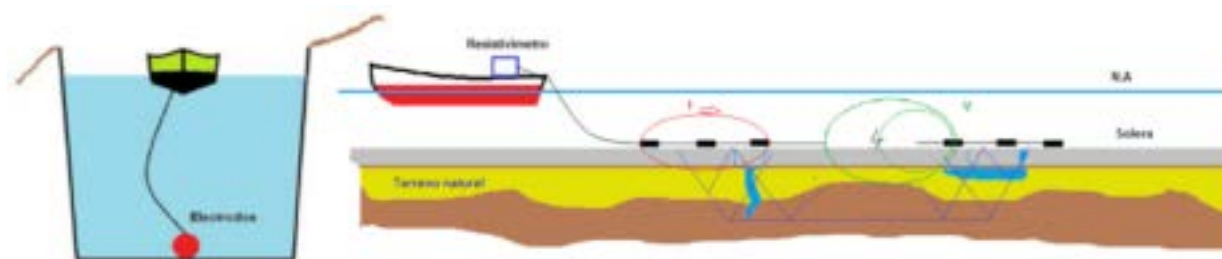

Conducting electrical tomography tests

Hydropower Europe project

Drawing up an R&D agenda and an action plan to be deployed in the hydraulic sector.

The objective of this project, begun in 2018, is to draw up an agenda to identify R&D needs in the hydraulic sector, as well as an action plan to deploy this agenda. This will be achieved through public debates and specialised technical forums which all relevant stakeholders will attend in order to identify research and innovation needs in this sector. The results of these activities, a Technology Roadmap and Research and Innovation Agenda will be published.

To reach this overall objective, the following partial objectives must be met

- Involve the relevant stakeholders
- Evaluate the challenges and prioritise needs.
- Draw up and disseminate the Research and Development Action Plan.

The Project is coordinated by ICOLD (International Commission on Large Dams) and has the participation of SAMUI (Samui France SARL), EASE (European Association for Storage of Energy), EUREC (Association of European Renewable Energy Research Centres – EUREC), VGB PowerTech e.V. (VGB), Zabala Brussels, European Renewable Energies Federation (EREF) and International Hydropower Association (IHA)

Ejector Effect

Increasing hydraulic production based on residual water flows

The project aims to develop a hydraulic model to obtain additional energy generation at no additional environmental cost, by taking advantage of the ejector effect of drainage waters in low-level hydraulic plants. The energy from spillway waters, which are not currently used and cause erosion of channels, could be used to increase energy generation while at the same time reducing the level of water in the plant outflow channel.

Dam security plan

Tools to analyse information and actions for dam security plans

The purpose of this project, carried out by Neoenergia, is to develop an innovative system of geographical references for the intelligent management of the dam safety plan, which includes equipment management, instrumentation management, risk analysis and data coherency in real time.

A decision support system will be developed based on real-time risk analysis, supporting decision-making by integrating several existing management systems in Neoenergia (SAP - DMS, SAP Accounting, SAP PM, SIGOC, SGT2, Solón, Ágil, etc.) to generate a dam safety plan, as required by resolution 696/2015, as well as indicating differentiated access profiles and allowing multiple hierarchical levels to be monitored.

Photovoltaic energy and other renewable technologies

Photovoltaic energy

Photovoltaic solar energy is one of Iberdrola Renewables' key vectors of growth, with a planned investment of more than 1.6 billion euros in the period 2018-2022. To consolidate this growth, the company believes that innovation is a key aspect which will reduce investment costs and increase operations and maintenance efficiency. To this end, work has continued on improvements in the design of photovoltaic plants and the search for optimised components.

At the Santiago photovoltaic plant in Mexico, 1,500-V monocrystalline panels, 1,500-V multi-stage inverters, DC buses and NILED connectors have been supplied, and the access road and internal subplant roads have been built using geotextiles and granular material to simplify the construction process. At the Hermosillo plant, also in Mexico, the foundations for the solar trackers have been built using micropiles.

Meanwhile, analysis by component type is being continued with the aim of conducting market surveillance to optimise costs, to be applied to areas such as the procurement of equipment for the Núñez de Balboa photovoltaic plant. In this study, the objective is to determine market leaders, cost optimisation trajectories and market trends, both in equipment and in design and installation practices.

Within the area of photovoltaic energy, and with the main objective of reducing maintenance costs, the Doctor PV project is being carried out, which is briefly described below.

Doctor PV project

The main objective of the DOCTOR-PV project is to optimise maintenance, moving away from corrective/preventive maintenance and toward maintenance based on the condition of the main plant elements.

In order to carry out predictive condition-based maintenance automatic learning methods will be used for early detection of faults in principal system components.

Also, the ability to make measurements based on electroluminescence (EL) and infra-red thermography (IRT) which will be analysed using drones. The use of drones will make inspections more efficient than traditional inspection methods.

The DOCTOR-PV project is being led by MAETEL and involves leading companies, universities and research centres in the field of monitoring, operations and maintenance of renewable facilities, with extensive specific experience in the field of photovoltaic generation. Specifically, the consortium is made up of 5 business partners, 2 of which (Gas Natural Fenosa and Iberdrola Renewables) are large companies, while the other 3 are SMEs with significant applied specialisation in the sector: MAETEL, (leader of the consortium), PARIVER and VISIONA. The University of Valladolid, CIRCE Foundation and the Public University of Navarra are also participants in the project.

Energy storage systems using batteries

Distributed Generation Resources

With this pilot project, Neoenergia aims to implement an ion-lithium storage system in a hybrid photovoltaic-diesel plant with a demand management system (DMS).

Also within the project, a true unity power factor converter will be developed based on a new control system that minimises losses and the risk of system disconnection, plus a multi-objective optimisation for energy resources (storage, photovoltaic plant, diesel plant and demand management) with the aim of making isolated microgrids sustainable and flexible.

Photovoltaic Solar Power Generation

Improved integration of solar photovoltaic generation in Brazil

The main objective of this project, being developed by Neoenergia, is to promote the deployment of photovoltaic energy in Brazil, a country with high solar resources.

To achieve this, a 1.0 MW photovoltaic solar plant is being connected to the grid, deployed and operated in the Recife Metropolitan Area. Also, two solarimetric stations have been installed with the main objective of prospecting solar resources in the city of Recife and in the solar plant, as well as a technology laboratory, which will be used as a reference when studying solar energy, as well as to certify components and systems.

Furthermore, the project includes the development of an electrical transformer, a key piece of equipment in solar generation projects. Through this project, the aim is to obtain good practices for the integration of this technology in Brazil, study its performance and the durability of components and provide appropriate technical and commercial solutions.



Solar Photovoltaic Power Plant



Solarimetric Station installed in Federal University of Pernambuco

Concentrated solar power generation

New design for Concentrated Solar Power (CSP)

The aim of this project is to develop a pilot CSP generation plan with parabolic cylindrical concentrator located in Jaborandi, Bahia, with a solar field of 5.16 MW (thermal), 0.5 MW power block and capacity to store 3 hours of electricity generation.

One notable feature of the project is the design of the parabolic solar collector, which incorporates secondary concentration in the absorber channel. This allows the output temperature of the solar field to be increased, as well as making the conversion and generation of electricity through the Organic Rankine cycle more efficient.



Solar energy plant in Fernando de Noronha

The project's main objective is to develop a 550 kWp polycrystalline silicon solar plant on the island of Fernando de Noronha. The plant's generation capacity is approximately 800 MWh per year, enough to reduce the consumption of biodiesel by 200,000 litres per year, equivalent to 5.4% of the island's consumption. This initiative forms part of the Energy Efficiency programme regulated by Aneel.



Hybrid Solar-Biomass Cogeneration System

CSP-Biomass System for Cogeneration of Heat and Power in the Agroindustry Sector

The purpose of this project is to create a prototype heliostat designed in Brazil for CSP-type solar generation plants, contributing to promoting this type of plant both in Brazil and worldwide. It will be developed in collaboration with Solinova and other national and internal companies with a wealth of expertise in CSP tower technology. Solinova is a Brazilian company currently responsible for the development and deployment of the SMILE project to create two thermosolar platforms in Brazil with cogeneration of power and heat at high temperatures.

The project will focus on applying CSP technology to the agricultural sector. It will develop the engineering necessary for the installation of a combined heat and power generation plant using CSP technology with 75 kW of power and 300 kWt of thermal energy from biomass. The heat generated by the field of 50 heliostats will produce steam through a receptor installed on top of a 25 m tower which will then be directed to a 75 kW generator which will supply energy to adjacent industrial production. During periods with low insolation or at night, the steam will be produced by a biomass boiler.

This type of cogeneration plant could be very appealing to operations that require both heat and power, such as feed factories, sawmills, etc.

Photovoltaic solar system directly connected to the secondary distribution network structure

Photovoltaic modules

The objective of this Neenergia project is to develop a solution to insert distributed generation modules into the distribution network using an innovative prototype to support photovoltaic modules, architecture for the electro-electronic connection, and a pilot plant which will undergo technical-economic and regulatory impact studies.

The application of disperse photovoltaic panels directly to the distribution network should minimise losses and overloads at peak hours in summer (normally between 2 pm and 4 pm).

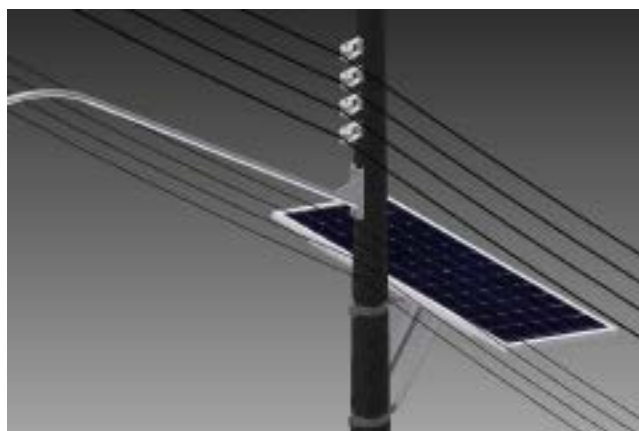

Development of a hybrid solar system to implement the multisolar concept

Multisolar

This project, developed by Neoenergia, is based on a hybrid solar system that uses the multisolar concept to maximise the use of solar irradiation on people's roofs.

The development will have an innovate solution to refrigerate the photovoltaic modules of the generation system. The modules will be hybrid photovoltaic-thermal modules that convert solar energy into both heat and electricity. It combines photovoltaic cells which convert solar energy into electricity with a solar thermal collector which eliminates unwanted heat from photovoltaic cells.

The project has a heat exchanger which adapts to the photovoltaic modules. Integrating the exchanger into the module will reduce its temperature by increasing the efficiency of the conversion of solar energy into electricity, while transferring unwanted heat to be used to heat water. As the majority of photovoltaic modules have very similar dimensions and configurations for a given power range, the product to be developed will have the technical characteristics necessary to allow adaptation, i.e. be efficient and cheap and easy to install.

Ocean energy

DTOCEAN Project

Optimal Design Tools for Ocean Energy Arrays



Iberdrola Renewables Energy and Scottish Power have taken part in the FP7 DTOCEAN project, financed by the European Union. The aim of this project was to expedite the industrial development of ocean energy and provide design tools for installing the first generation of wave and tidal current converters. During the project, software was developed to optimise the design of wave and current generation plans using five modules:

- Electrical design module
- Hydrodynamic design module (Array Layout)
- Foundation and anchorage design module
- Installation module.
- Operation and Maintenance module

The design was optimised using three criteria:

- Updated cost of electricity
- Reliability
- Environmental Impact

The project, completed in 2016, had 18 industrial partners and collaborating research centres.

In the tool's development, Iberdrola's vision as developer was taken into account to make it as useful as possible to end users.

OPERA Project

Open sea operating experience to reduce wave energy costs



The cost of wave energy is very high in comparison to other forms of renewable energy. This is partly due to the limited operating experience of wave energy conversion devices in the open sea, which makes it difficult to study the performance, survival and reliability of these devices. In this project, an orderly and methodical process will be carried out to collect information from one of these devices (OWC Oceanec) installed at the BiMEP test site. Iberdrola Engineering has participated in defining the engineering processes and operating marine energy generators.

The project is being led by Tecnalia and involves 12 partners from 4 countries (Spain, Portugal, the UK, and Ireland). As well as the data collection and analysis methods, 4 disruptive technological improvements will be made to the converter, resulting in an impactful improvement of the system's LCoE.



HiWave Project

This project aims to create a new wave energy device to lay the foundations for the design of an offshore wave farm using this technology. The collaborators in the project include Iberdrola Engineering and Cor-Power (as device developer and project leader, respectively) and the Portuguese marine research centre WaveEc.

The project objectives are to advance the design of the technology to TRL 8 and demonstrate the functionality of the entire system, converter, anchorings, connection to the grid, remote control and communications. At the same time, the project strives to acquire operational experience through scale testing in two real environments to obtain energy production models and data. HiWave is partially financed by the European Institute of Innovation & Technology (EIT) through one of its innovation and knowledge communities (KIC-InnoEnergy).



Biomass

LIGNOCROP Project:



Lignocrop's main objective was to promote a sector dedicated to energy crops in an environmentally and economically sustainable manner. Its ultimate aim is to supply fuel to electrical or thermal power plants. The project began at the end of 2010 and finished in 2018.

The aim was to demonstrate the technical and economic-financial viability of woody energy crops as an alternative that complements traditional crops, revive activity on marginal lands and look at the impact on employment and wealth creation produced in the rural setting where they are implemented.

It was the first initiative on a pre-industrial scale to develop a study on optimising the entire energy cultivation logistics chain: genetic selection, production of the plant in the laboratory, growth in more suitable locations, harvesting and preparation processes, biomass conditioning and delivery to the final customer.

It consisted of a total of 60 hectares of woody energy cultivation located in four geographically and meteorologically distinct areas: Peñafiel (Valladolid), Tahivilla (Cadiz), Molina de Aragón (Guadalajara) and the plain of Granada.

Work is being undertaken to identify the main parameters that will allow not only cost and production efficiency to be controlled and improved, but also the efficient management of key environmental aspects.

To do this, studies are being undertaken of the biodiversity present in plantations, which act as refuge areas in the Spanish agricultural landscape, as well as analysis of the impact of cultivation on the quality and evolution of the soil, monitoring of water use, monitoring and analysis of operations to establish efficiency, etc.



Biogas

Generation of electricity from biogas from anaerobic reactors in residual water treatment plants

This project, led by Neoenergia, aims to analyse the technical and economical feasibility of generating electricity from the residual water treatment process on a real scale.

The results of the project have been used to define a solid and systematic evaluation method to study the feasibility of electricity generation from biogas from residual water treatment plants with upflow anaerobic sludge blanket (UASB) reactors in Brazil. This has promoted, at a national level, the potential for using urban sewer systems as an alternative electricity generation source. A biogas plant has been installed in Feira de Santana, Bahia.



Biogas Plant

Biogas in scattered biodigesters

Distributed generation based on scattered biodigesters

This Neoenergia project aims to build a pilot distributed electricity generation plant that will use biogas from residual water treatment plants, with a minimum installed capacity of 200 kW. As a result of the project, it is expected that new technical and economic models will be obtained to study the feasibility of distribution based on biodigesters scattered throughout the Brazilian electricity system.

Currently, monitoring is being conducted on a microgeneration plant using biogas from solid waste with an installed capacity of 30 kVA.



Micro Generation Plant for Biogas from solid waste

Production of electricity from wastewater flows

Production of electricity from hydraulic energy present in wastewater flows

In this generation project, a turbogenerator was developed to produce electricity from wastewater located at 38 metres. The power of the turbogenerator is around 850 kW, and the plant produces 4,468 MWh per year. This project forms part of the Energy Efficiency programme regulated by Aneel.



Environment

Analysis of environmental risks at renewables facilities

ARIAN Project

The objective of this project is to draw up a method to analyse environmental risks in wind farms and mini-hydraulic plants based on the Spanish UNE 150008:2008 standard and develop a support tool (ARIAN) which will allow this method to be applied to these facilities. The tool is currently being used in the operation phase of several facilities.



Example of the information shown by the ARIAN tool when the accident 'Lightning strike in an HV line in Wind Farm 1' is selected. The result of the risk calculation is Very Low for all environments, as shown by the risk matrices (marker in green zone), which also show that the scenario is probable (probability=3) and the damage is Not Relevant.

The environmental risk for the different recipients (natural, human and socio-economic environments) is estimated by selecting a facility and an accident scenario, which allows the initiating event, source of danger, extent or area affected and other parameters to be chosen.

The risk is calculated as a product of the damage and the probability and is represented graphically for each environment in the risk matrices, which contain a marker that shows the result of the risk (from the colour of the zone it appears in), the damage (x-axis) and the probability (y-axis).

To make these calculations, the application uses information from multiple databases including the DOMINA database, which contains information on facilities (code, province, power, etc.), and others created specifically for the application (with data on sources of danger, initiating events, information on the environment, etc.).

BRIO Project

Demonstration of wind turbine rotor Blade Recycling into the Coal Clough Wind Farm decommissioning Opportunity



Iberdrola Engineering, together with two research centres from Spain's Basque Country, has implemented this project which uses total life cycle management technology to demonstrate the technical-economic feasibility of the wind turbine blade recycling process, specifically focused on the high-added-value fibres they contain. As a complete process, it includes the analysis of mechanical dismantling, separation and recovery processes and the reuse of these elements in concrete prefabs, multilayer panels, etc.

The project also includes regulatory analysis in Europe of the recycling of these components, as well as legislative recommendations. In leading the project, Iberdrola Engineering has mainly focused on the dismantling process and the environmental feasibility of the process. Scottish Power Renewables has collaborated by providing two decommissioned blades, which were used for all the tests and demonstrations undertaken as part of the project.



R&D+i in the Retail Area

Innovation is one of the essential elements and one of the main characteristics of retail activities. The speed at which markets, technology and consumer needs are changing makes constant upgrading essential.

It is also essential to create new systems for retrieving, analysing, processing and managing information, affording in-depth knowledge on each user and their value to the company, their experience and perception. This provides the capacity to offer them the products, services and attention most suited to their specific needs.

It is also vitally important to understand and be at the forefront of technological advancements and developments that allow Iberdrola to offer an energy supply and services, equipment and technologies that are ever more efficient and environmentally friendly.

To this end, much of the work carried out by the commercial team is innovative in nature, whether in their day-to-day work or through innovation projects, clearly oriented towards problem solving and in line with business targets and the critical processes involved in retail activity.

The section **Constant innovation in products and services** contains more detailed information on the projects carried out in this area.

IBERBILL

New international calculator

This project stems from the need to place more value on information from customers for optimal billing calculation and to process information from all countries in a unified way, with the aim of avoiding redundancies and achieving an agile, efficient system that provides quality service to customers.

To this end, we have opted to develop a new, powerful and flexible international calculator that can respond to the needs of the countries we are present in and allow simple and efficient pricing and billing.

Due to the complexity of this project and in order to ensure the achievement of its objectives, it was considered necessary to adopt a work methodology with two clearly differentiated stages:

1. Analysis and design of the new calculator.
2. Development of the new calculator.

This new calculator requires harmonisation of all of Iberdrola's existing procurement, billing, accounting and other systems.

Focusing on the progress made in 2017, in its initial phase this project covered domestic electricity billing in Portugal, with the following milestones:

- XML upload.
- Item calculation process.
- New billing items (old model).
- Bill creation process.
- Manual billing.
- Mass cancellation of DCOs from file.
- Automatic resolution of any anomalies.

In the same period, and outside the scope of the project in Portugal, other initiatives were implemented in other countries which also had an impact on the new international calculator, such as the bill uploader solution for uploading bills to DELTA in countries where new companies are created.

The aim of this solution is to upload bills calculated externally in different countries to DELTA and associate them with the new companies created in each country.

CAPCLIENTE

New customer acquisition strategy

Combining commercial process optimisation needs with new technologies, this project aims to design and develop a new application that allows Iberdrola sales agents to perform the recruitment process from a tablet device, additionally includes various functionalities both planning campaigns and monitoring sales at residential and SMEs.

This new application will centralise and optimise sign-up processes, speeding up the assessment of commercial strategies and promoting changes focused on improving the customer experience.

Chatbot connected to the interactive voice response service

The aim of this project is to make it easier for our customers to manage their requests by using a chatbot connected to the interactive voice response (IVR) service. Neoenergia will offer the possibility of ending the call and finalising the process through WhatsApp with the help of a virtual assistant.

A pilot was carried out in Coelba, with 25% of participants choosing to finalise the process using IVR. From 2019, the pilot will be extended to more digital contact points in all Neoenergia businesses.



R&D+i in the IT Area

In the period 2016-2018, the IT areas dedicated its efforts to guaranteeing the improvement of efficiency and productivity of the services offered to our customers worldwide through all Iberdrola Group companies and with the support of all corporate areas. In a changing world, we have committed to trialling disruptive concepts using emerging, differentiating technologies to enhance the digital transformation our company is undergoing.

As part of the constant innovation conducted by the IT area, in line with Corporate Innovation, the IT area achieved UNE 166.002:2014 certification in 2016 and renewed it in 2017 and 2018 in all of the countries in which it operates: Spain, the UK, the USA and Brazil. The aim of the certification is to maintain a systematic innovation procedure, active technological surveillance, constant communication with technological partners and to contribute to tax deductions for the Iberdrola Group.



Connected vehicle

Initially, the scope of this proof of concept was the mapping of the communication networks that cover the Elektro concession area, implementing an internet of things solution to create a connected vehicle. The vehicle also incorporates sensors to monitor certain parameters such as tyre pressure and the presence of spare tyres. The aim is to identify the applicability of the connected vehicle which, using a device to securely connect to the Elektro network using 3G/4G/satellite, will provide a corporate wifi access point to devices and sensors connected to the vehicle. The vehicle will therefore be able to securely communicate in real time with the central office, facilitating fieldwork, increasing speed and safety, and monitoring the condition of the vehicle and the behaviour of the driver.



Gamification for Wind Turbine Engineers

The objective is to develop a simulator to conduct analyses and tests on wind turbine generators. The simulator is based on the principle of gamification (game mechanics), which involves using game-like techniques, elements and dynamics in non-recreational tasks in order to boost motivation and improve user commitment, organisational productivity, learning, ease of use and the usefulness of systems. This PoC will use a gaming platform to improve operational learning processes and competencies. Specifically, the simulation will focus on the wind turbine maintenance process. Engineers will use this process to evaluate their knowledge and skills.



Social Customer Relationship Management

The objective of this proof of concept is to identify a tool to monitor the presence of Iberdrola and its customers on social media and interact with them in response to their needs. Analysing users' trust and feelings through monitoring is a critical need for the commercial business. This new tool will cover marketing needs in the area of social engagement and monitoring. Currently, Iberdrola is present on social networks including Facebook, Twitter, YouTube and Instagram.



Reverse engineering in cable maintenance

The objective of this PoC is to use reverse engineering to improve the maintenance of cables in cable trays at the Cofrentes nuclear plant. The idea is to carry out a topographic study and 3D laser scanning of a location within the plant in order to take 3D photographs to assist navigation. The data recorded will include the measurements, annotations and GPS locations of the components. A 3D mechanical model will then be designed using the list of materials, and finally, 2D and interactive 3D PDF schemes will be created.



HSSE Monitoring Platform

With this project, Iberdrola Networks aims to predict and prevent work accidents and improve the wellbeing of employees. The aim of this proof of concept is to provide an internet of things-based safety solution which can respond to multiple use cases. The objective is to prevent accidents among field squads by using a series of connectors fitted to helmets to detect impacts, the wearer's vital signs, electromagnetic field warnings and GPS location. The connectors will also make it possible for workers to communicate with the control centre and include a panic button for communicating emergencies, all controlled by a central emergency response system.



Automatic document capture

The objective of this proof of concept is to help retail customers locate key data on their bill, such as the CUPS (unique supply point code) and identification card, when signing up to electricity with Iberdrola. The idea is to test the possibility of using an optical character recognition device to locate these codes on bills. This will allow the creation of a new process for automatically managing sign-ups on the consumer website.



Augmented reality in field operations

The idea is to explore the use of *wearables* that incorporate augmented reality systems to help field operators perform tasks such as locating buried/aerial transmission infrastructure in poor condition. Sometimes, maintenance teams have communication difficulties due to the fact that the technician in the field is not necessarily specialised in the equipment in question, does not speak the same language or is in a noisy environment. By using an earpiece with smart glasses and tapping into the communications network provided by the connected vehicle, an operator in the field can share the fault detected with an expert or get technical guidance to be able to solve the problem with optimal reliability.



Storm Operation Dashboard

This proof of concept is aimed at creating an emergency events console that will provide an alert regarding the presence of a circumstantial event and ensure the consistency of the information available on it. Stakeholders will use the console to monitor and track restoration efforts, which will allow critical decisions to be made more efficiently and effectively and give a single and reliable source of data to the command structure during an emergency situation. This centralised dashboard will contain an informative summary, including the number and type of customers affected, monitoring of restoration resources, estimated restoration times and a summary of key incidents.



Damage Prediction Model

Emergency response teams need accurate estimates of outages and damage 1-3 days before a weather event occurs. This gives better support to decisions about when and where to send teams, comparisons of the cost threshold in relation to the regulatory remuneration from the Public Service Commission, and the placement of equipment. It is also fundamental to increasing confidence in restoration estimates in general, with smaller precision intervals for restoration and energy simulation platforms. Finally, it is important to define in greater detail the relationship with and the visibility of vegetation management, as this helps prevent outages and affects how they are managed. The objective of this proof of concept is to demonstrate, using a predictive model, the level of precision of the weather forecast with the current model in the Brewster, NY, area, which is prone to storms, and compare it with the level of precision of the UCONN damage prediction model, which borders the same territory as Brewster.

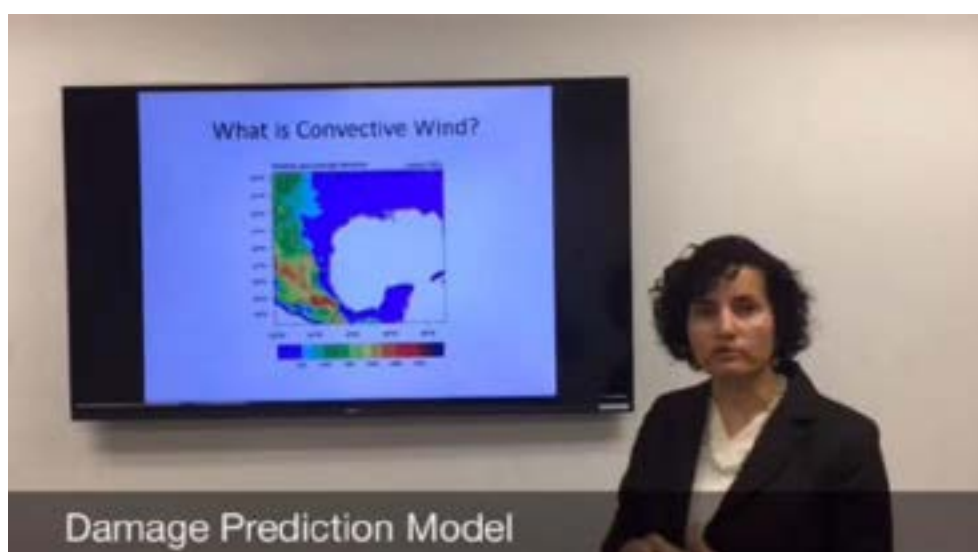

Virtual Assistant for Retail

The objective of this innovation initiative is to produce a proof of concept for Amazon Alexa Skills. Using voice recognition technology, customers will be able to carry out certain self-service tasks themselves (voice-activated), thereby lightening the load on call centres.



Machine learning for retail complaints

The objective of this proof of concept is to analyse the capacity of artificial intelligence (AI) tools to automatically classify complaints. It will also be essential to understand which additional features can be implemented alongside automatic classification, speech to text, opinion analysis, automatic resolution, and conversion of text from scanned documents.

The idea is to test how artificial intelligence/cognitive solutions can improve the current complaints classification process for customers in the UK and Spain. Artificial intelligence must provide new tools and processes to classify and deal with customer complaints in a quicker and more precise way. The solution will prevent delays to responses due to unclassified or misclassified complaints.



Energy disaggregation solution

The purpose of this proof of concept is to help Scottish Power and Iberdrola identify the special benefits, use cases and appropriate technology solutions around compiling, processing and the possibilities of sharing energy disaggregation data using machine learning technologies. The objective is to provide value to all customers by disaggregating energy consumption to give a detailed and personalised breakdown of home energy bills using a mobile app or website. The solution converts domestic energy usage data into powerful ideas and recommendations that can spark long-term changes in energy consumption, provide personalised energy education opportunities and create a more solid commitment between the utility and the consumer. This solution is specifically for ScottishPower and Iberdrola smart meter customers.

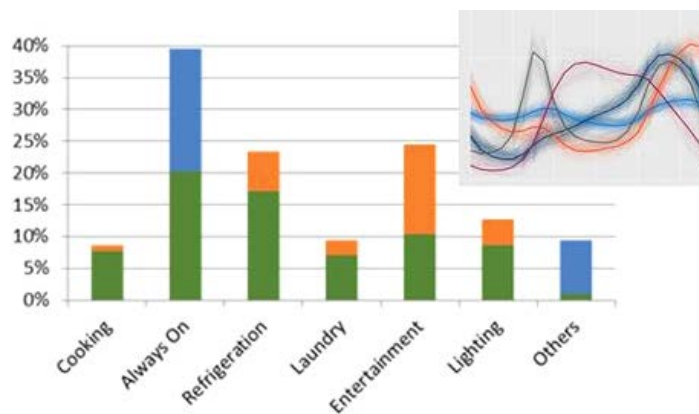

Materials Inspect

The objective of this proof of concept is to improve the procedure that generation technicians use to inspect materials. Using a smart solution (app), we can reduce the amount of time spent making technical reports. The aim is to improve the gathering of information on inspected materials in order to be more efficient and increase productivity. This means that the inspector can make use of an application to gather information such as images, notes, comments, etc. and facilitate the creation of the final report. This solution will also facilitate integration with the final part.



Biometric signature

The objective of this proof of concept is to test a combined biometric technology to guarantee the identity of a person when they interact with a capture device such as a fingerprint reader, iris scanner, voice recognition, signature recognition, etc. The idea is to analyse at least two credentials, such as face and signature, because the advantage of using combined biometric technologies is that they guarantee solid authentication.

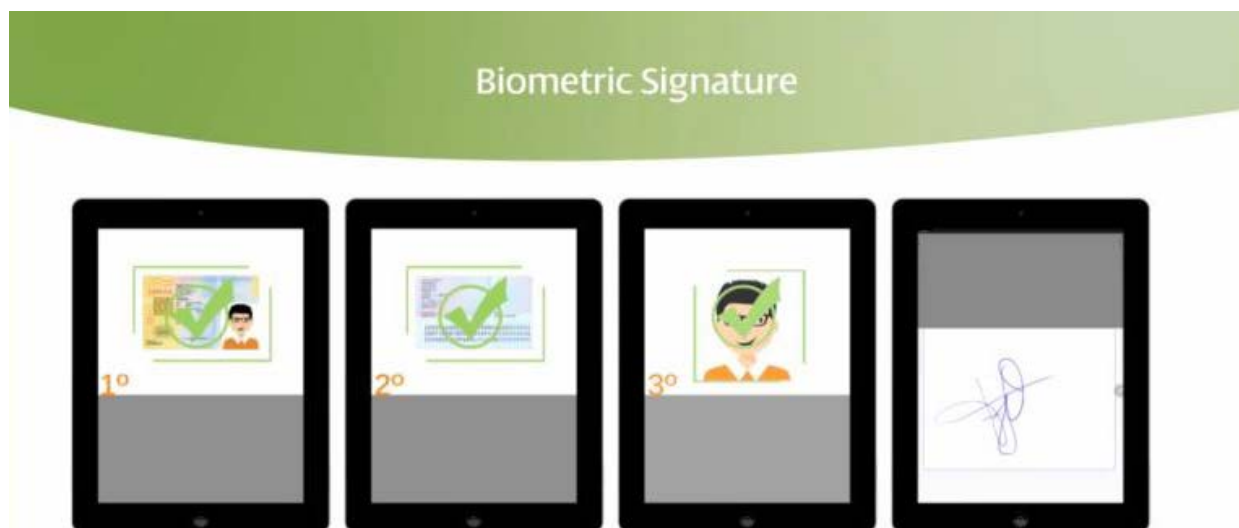

Self-Service Predictive Models

The objective of this proof of concept is to test out a centralised solution with a powerful and robust graphical user interface which lets users create, submit and track predictive analyses. The idea is to validate a strong and collaborative analysis platform to accelerate the creation, submission and tracking of high-value data science. The solution must offer more functions than any other visual solution, and will also be open and scalable to satisfy all data science needs, providing technology which is useful when working at all stages of an advanced analytical project.

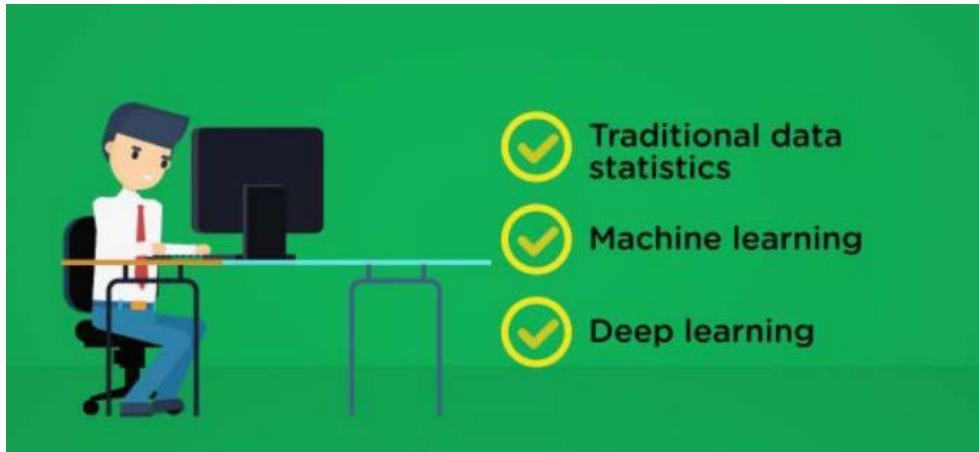

Customer service centre search engine

The objective of this PoC is to test a solution that will let customer care centre operators locate information quickly. The aim is to reduce waiting times for customers and reduce the need for subsequent calls.

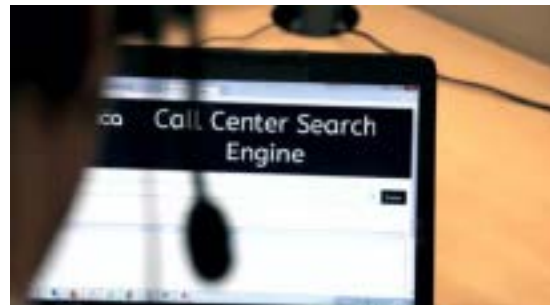

Chatbot for Retail

The objective of this PoC is to develop a chatbot for the Iberdrola website and integrate it into the Customised Electricity Plans section. This will give customers responses to any questions they have about the product or the sign-up process.



Smart grid of gas pipelines

The objective of this proof of concept is to trial a global solution to improve the monitoring and control process for the pipeline network using IT/OT integration. The scope covers pressure monitoring and and its integration to create work orders in SAP.



Gas pipeline monitoring and tracking (AR/VR)

The objective of this proof of concept is to deploy an augmented reality tool integrated with the Avangrid pipeline network to help field operation teams in the maintenance process. Technicians will use the augmented reality application to identify underground assets.



Cybersecurity using blockchain

The objective of this PoC is to trial Blockchain technology in maintaining the security of IoT devices. Router manufacturers and the software developers that provide the blockchain IoT security protocol took part in the trial. Together, they are demonstrating the use of blockchain technology in the AMI space to Avangrid.



Automatic thermographic inspection

Electrical infra-red thermography is a useful tool that can detect defective elements in an electrical installation before they fail or cause a fire. This gives us the opportunity to resolve the problem as part of preventive and planned maintenance before an incident occurs.



Digital Assistant

The purpose of this initiative is to research and demonstrate the benefits of using a knowledge management tool as a way of giving call centre agents real-time support during a call.



Desk Occupancy IoT

This project will implement a PoC based on IoT technology (data capture and visualisation using sensors) and low-power wide-area networks. To support this initiative, we are using a specific request from General Services to monitor desk use at Scottish Power House.



Cognitive assistants to automate customer service

The objective of this PoC is to demonstrate that virtual agents are capable of resolving customer queries over the phone without any human interaction. The case study was "Change of payment details" in the Retail Contact Centre.



Smart Thermostat

The objective of this PoC is to develop a solution to remotely operate thermostats in customers' holiday homes.



Management of intercompany contracts using blockchain

The objective of this proof of concept is to trial the application of blockchain in Iberdrola's internal Financing Area, specifically in a "revolving contract" between two Spanish companies.



Robotisation of the gas acquisition process This PoC consists of the automation of Iberdrola's gas acquisition process through the Third-Party Logistics Access System. This system can be used for acquisition requests, procurement, planning, gas meters, balances and billing support.



Using 3D VR models for operational planning

The objective of this PoC is to deploy 3D model interfaces using augmented reality (AR) devices, improving those currently used in Iberdrola construction projects.



Augmented reality in network maintenance The objective of this PoC is to integrate an augmented reality tool into Iberdrola's network inventory to help teams in maintenance and incident response to view and locate elements affected by maintenance work orders using a mobile phone camera.



Cognitive Entity Recognition for technical docs

The objective of this PoC is to trial an automatic data recognition and processing system capable of learning different document formats and to then link this data with technical objects in Iberdrola's central systems (GIS and SAP).

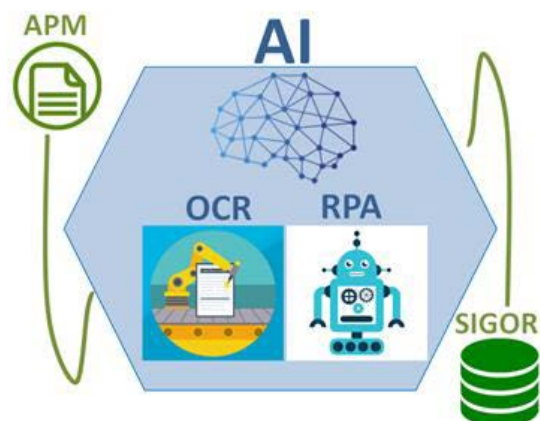

Voice assistant for customer queries

The objective of this PoC is to trial voice assistant technology to allow Iberdrola Distribution customers to check and send the status of electricity service connection applications.



Electricity Labelling with Blockchain

The objective of this proof of concept is to use blockchain to document renewable energy certificate transactions in a decentralised way: From the recording of GoO (guarantee of origin) at the time it is generated, until the GoO is negotiated through a blockchain platform.



R&D+i in the Safety and Prevention Area

Facility Safety and Occupational Risk Prevention both constitute fundamental pillars of the company's current philosophy. Moreover, their importance today has been bolstered by the great advances in Information Systems insofar as innovation yields fresh points of view to help achieve the objectives set out in the different identified lines.

In terms of Occupational Risk Prevention, Iberdrola's innovation culture together with the proactivity of its human team have resulted in new ideas and practices that enable it to carry out its daily tasks more safely.

In terms of Safety, various innovation lines seek to guarantee the structural integrity of production facilities through projects centred on their life cycle management and they include new developments that cover hypothetical events and go beyond the design bases with which these facilities were originally built.

The cybersecurity line includes not only data and system protection but also operation and maintenance procedures. Information technology security comprises the systems in charge of guaranteeing the protection of information from attacks against software and hardware vulnerabilities, and the continuity of the business through the recovery of critical work environments.

DIGINUC

Modernisation of the distributed control system for nuclear plants

In this project, new advanced monitoring and control functions have been developed for the nuclear plant distributed control system, allowing diverse elements to act in a centralised way and incorporating a new advanced layer of cybersecurity to protect the entire system.

These new developments have allowed nuclear plant distributed control systems to make an evolutionary leap through the following specific objectives:

- Increase control over different units in the plant using new smart actions that eliminate operational risks in different systems.
- Increase the security and reliability of information on the plant.
- Develop new communication interfaces for better information processing and more detailed and earlier analysis of plant conditions.
- Design new cybersecurity actions to protect the new controllers developed.
- Total protection of control and data acquisition system communication networks.

PREXES

New prognostic methodology for structures with alkali-aggregate reaction (AAR)

The PREXES project involved research into the distribution and degree of advance of expansive phenomena in concrete in dams caused by alkali-aggregate reactions to then develop a mathematical predictive model to evaluate future concrete damage, thereby increasing the ability to detect these anomalies in hydraulic dams, increasing their safety and useful life.

The specific objectives of this project were:

- Generate new scientific knowledge on evaluating the level of degradation and degree of reaction of aggregates in different areas of the dam due to expansive phenomena in concrete.
- Understand the fraction of the reaction consumed in a determined amount of time and the potential evolution of this reaction in the concrete under the environmental conditions it is exposed to (temperature, humidity and stress state).

- Make available a mathematical model with the capacity to predict expansion phenomena due to alkali-aggregate reactions in order to evaluate structural stability and functionality with greater reliability.
- Determine the volumetric expansion and distribution of deformations cause by reactions in each direction.
- Zone dams based on the values of the parameters that determine expansive phenomena in concrete, which will increase the efficiency of the dam auscultation system and predict the need for intervention.

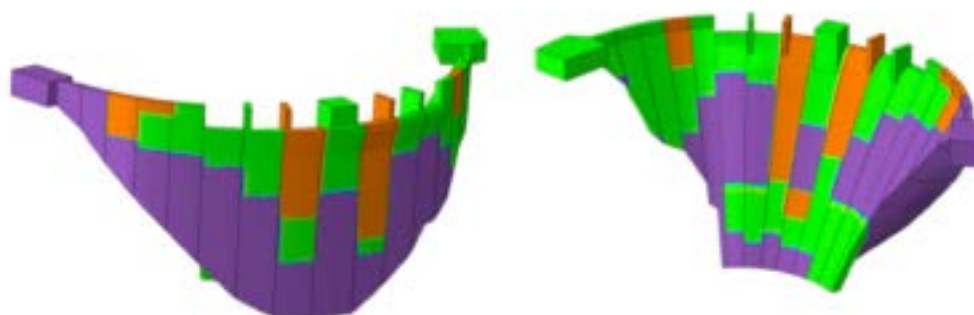
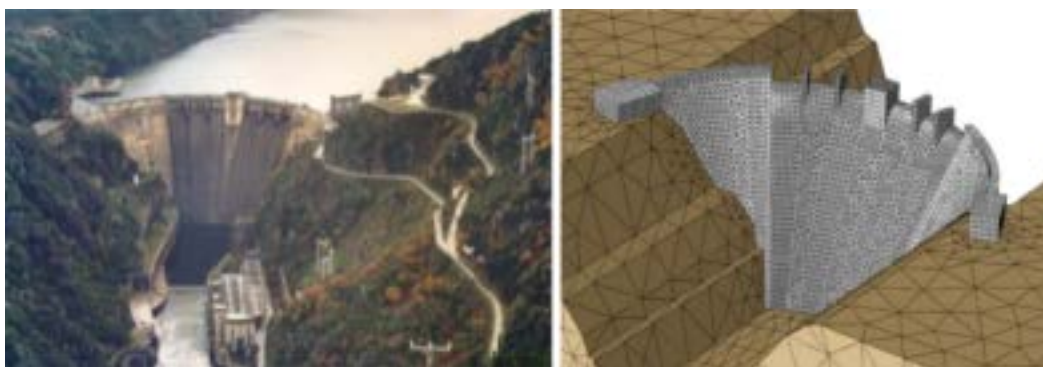

OPD

Open-phase detection system for nuclear power plants

The overall objective of the project is to design, develop and experimentally validate an open-phase detection system for nuclear power plants. The OPD project will therefore contribute to developing even safer nuclear technology and guarantee the supply of electricity to auxiliary systems (whether unloaded or in stand-by) by developing an autonomous and automatic detection system capable of detecting open phase conditions, that until now have gone unnoticed by the undervoltage detection systems of nuclear power plants. Furthermore, it is expected that the technological developments achieved in the project can be extrapolated for optimal supply of power to auxiliary equipment used in other types of power plants, such as thermal and hydroelectric plants.

The specific and operational objectives met in order to achieve the principal objective are listed below:

Specific objectives:

- Study the open-phase condition and detect it under all operating conditions and all possible alignments of all external and internal power supplies.
- Study the possible configurations of the power system under normal operating conditions as well as under error conditions.
- Design, develop and validate the adjustments associated with the overcurrent protection system of the neutral wire in the detection system, including the specific protection and manoeuvring elements in the capacitor bank.

Operational Objectives:

- Develop simulation models based on the Alternative Transients Programme (ATP) on open-phase conditions with and without a detection system.
- Define the specifications and design the architecture for the OPD system, initially on a laboratory scale, then on a real scale.
- Validate the detection systems developed on a real scale by creating real open-phase conditions and monitoring their behaviour.

RESONUC*Development of a resonance mitigation methodology in critical nuclear power plant systems*

This project permitted the research and development of a technology solution to mitigate the phenomenon of acoustic vibrations causing anomalous behaviour in SRVs (Steam Relief Valves). The solution is based on an innovative system to monitor acoustic oscillations in real time inside the main steam lines and a new design of an experimental jacket to prevent vortices being created around SRVs in BWR-6 (Boiling Water Reactor – 6th Generation) nuclear power plants.

As part of this solution, a 1:2.59 scale model of the main steam line was developed. This makes it possible to faithfully reproduce the phenomenon caused by dynamic pressure oscillations inside the main steam lines of a BWR-6 plant to identify the exact behaviour of SRVs and ensure they function correctly in the long term.

Some of the more prominent technical objectives of the project include:

- Eliminating the risk of anomalous behaviour in the SRVs in the main steam lines of the emergency core cooling system, which could activate pre-emergency situations and trigger unscheduled stops at BWR-6 nuclear power plants.
- Maximising the degree of safety in operating nuclear power plants, eliminating the occurrence of events associated with SRVs spontaneously opening.
- Increasing the degree of availability of power generation at nuclear power plants by eliminating potential emergency situations that could cause temporary shutdowns, decreased plant performance and the amount of energy produced and fed into the grid.
- Expanding knowledge regarding resonance phenomena affecting all SRVs on the main steam lines.
- Mitigating the vibrations in the main steam line by varying the operating mode at the plant based on the acoustic vibrations measured in real time and/or modifying the internal configuration of its components by installing the new validated experimental solution.



Modelo 3D de la Válvula

Cálculos Fluidodinámicos

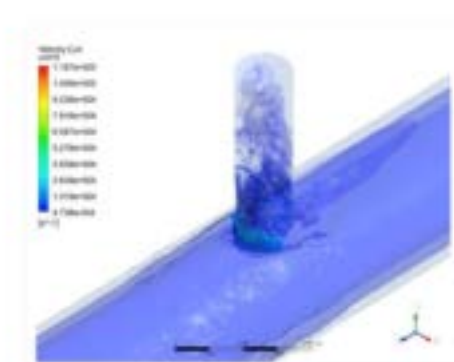
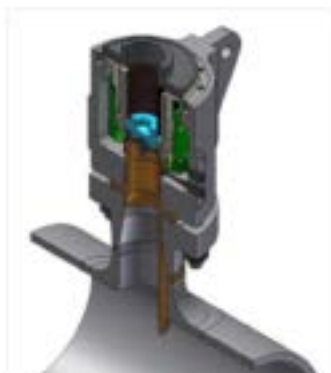

FILTRONUC

Filter at the containment building vent

The goal of this project was to research and develop a new containment filtered venting system for BWR-6 nuclear power plants with Mark-III containment for maximising filtering performance on the venting line without compromising the safety and integrity of the facilities. The system can trap the radioactive particles and species which could be released to the exterior in the event of a severe accident (damage to the reactor core).

This overall objective can be broken down into the following specific objectives:

- Increase the robustness and operability of the system in prolonged SBO (Station Black-out) conditions.
- Reduce the need for containment venting action in a Severe Accident, thus significantly minimising the source term released to the exterior.
- Achieve maximum efficiency, bolstering the use of mitigation measures at the plant with containment vents without affecting existing control functions.
- Develop a new filtering system without affecting the current non-filtering venting system functions insofar as their use in Emergency Operating Procedures.
- Provide a robust system in the event of external natural phenomena or fuel gases in venting lines throughout the full operating range in case of a severe accident.

- Maximise performance of the filtering system on the vent line to the exterior in case of severe accident.



Recombiners

Development of New Passive Autocatalytic Recombiners

This project was centred around the development of a new technology for passive catalytic recombiners used to eliminate the hydrogen that would be generated in a severe accident scenario caused by the loss of reactor cooling or full electricity supply black-out. This new development involved making hydrogen react with CO, combining it with oxygen to produce water and carbon dioxide respectively and guaranteeing the integrity of the containment.

Some of the more prominent project objectives include:

- Discovering and developing new solutions to increase the safety at BWR nuclear power plants.
- Increasing the safety and reliability of the hydrogen elimination process by transformation to other compounds that cannot generate explosions.
- Resolving all uncertainties regarding engagements involving the reactor, containment building and dry well facing a total electricity supply failure or cooling loss.

The project was divided into two activities:

- Development of new systems to eliminate hydrogen in the containment in the event of a severe accident: passive auto-catalytic recombination systems were able to be built based on the analysis of sequences generated by a severe accident, the simulation of oxygen flow after release and hydrogen accumulation studies in the potential failure scenarios.
- Development and engineering on the passive autocatalytic hydrogen recombiners.



Prototype passive autocatalytic recombiners (PAR)

Improve management and safety in the field*Use of radiofrequency to identify protection equipment*

This Neoenergia project aims to apply radiofrequency technology to identify protection equipment. More specifically, the aim is to use radio frequency identification prototypes in individual and collective protection equipment used in field operations, making it possible to monitor vehicle protection equipment, verify the execution of isolation processes and preparation of areas that require the intervention of field equipment, remotely monitor the use of personal protective equipment (PPE) in the field, and develop a computational tool to monitor field operations (online and offline).





Annexes

Innovation Policy

The Board of Directors of Iberdrola, S.A. (the “**Company**”) steers innovation within the Company and the companies integrated in the Group whose parent company, as defined by law, is the Company (the “**Group**”), towards an increasingly efficient management of available resources and knowledge, while assuring that the most appropriate technologies are introduced efficiently to generate benefits and competitive advantages for shareholders, customers, employees, and other Company stakeholders.

1. Purpose

Innovation is a strategic variable that affects all Group businesses and all of the activities it develops.

This *Innovation Policy* is a harmonised extension to the Group's values regarding innovation and it aims to define and disseminate the strategy for empowering the Company and its Group to be the innovation leaders in the energy sector. The Group's core activities in this field comprise sustainable development, the promotion of renewable energies and emerging technologies, always in strict compliance with the pertinent legislation in force and all other Group-assumed commitments.

The Company understands innovation as a decentralised and open process. Decentralised because it is carried out independently within each business unit with the support and coordination provided by the Company's Innovation, Environment and Quality Department, which reports to the Chairman's Area. Open because the Company views itself as a technology-driven entity and, as such, its aim is to involve the Group's technology suppliers such as universities, technology centres and equipment manufacturers in the innovation process.

Likewise, the Company believes that the innovation process should be consistent throughout all business units and, to make this so, the Innovation, Sustainability and Quality Division is responsible for across the board standardisation.

2. Basic principles of action

The *Innovation Policy* is based on the following basic principles:

- a. Foster research, investigation and innovation activities (R&D+i) centred on efficiency, oriented towards constantly optimising the operations of the Group's businesses, managing the useful service life of facilities and equipment, reducing operational and maintenance costs, decreasing environmental impact, and the development of new products and services to satisfy the needs of our customers.
- b. Place the Group at the cutting edge of new technologies and disruptive business models by engaging in an “innovative culture” impregnated throughout the entire organisation for fostering motivating work environments that favour and incentivise the generation of ideas and innovative practices rendered by professionals, the acceptance of risks and the recognition of creative contributions.
- c. Achieve innovations that benefit sustainable growth and efficient resource management while contributing to the social and economic development of the environment in which the Group carries out its activities.

- d. Develop projects to render power services universal, based on sustainable environmental models that are economically feasible and socially inclusive.
- e. Integrate innovation in all the training provided by Group companies through specific courses and programmes to develop creativity-related capabilities.
- f. Implement an innovation management system that includes establishing annual targets and objectives within a process of continuous improvement, managing the company's human and intellectual capital as genuine supports to the entire creative and innovative process.
- g. Promote a technological surveillance and prospecting system to identify opportunities and challenges for Group businesses, and detect the innovation-related needs of its processes or services to thus anticipate technological changes in the market.
- h. Promote collaborations and alliances with academic circles and other stakeholders through links created with a view to multiplying the Group's innovative capabilities.
- i. Disseminate generated knowledge internally so that professionals understand the best practices applicable to their activity in seeking to increase the efficiency and effectiveness of Group processes.
- j. Safeguard the results of the innovation process, appropriately and ethically manage intellectual and industrial property, which in any case entails observing the rights of this nature held by third parties.
- k. Boost innovations that afford added value to users and increase the satisfaction of shareholders, customers, employees and other stakeholders.

3. Innovative strategy of the Group's listed subholding companies

The provisions of this *Innovation Policy* under no circumstances prejudice the enhanced autonomy that the Group's listed subholding companies enjoy to define their own innovation strategy, which must nevertheless be consistent with the strategy established for the rest of the Group and in line with this *Innovation Policy*.

This *Innovation Policy* was initially approved by the Iberdrola, S.A.'s Board of Directors on 18 December 2007 and was last amended on 23 February 2016.

Knowledge Management Policy

The Board of Directors of Iberdrola, S.A. (the “**Company**”), aware that its intellectual capital constitutes a basic pillar for the creation and protection of its corporate value, recognises as a strategic objective, the need to implement an adequate Knowledge Management Policy to promote initiatives, procedures and tools which allow the Company to effectively make use of its intellectual capital.

1. Purpose

The ultimate aim of this *Knowledge Management Policy* is to disseminate and share the knowledge that exists within the company along with continuous learning and cultural exchange to increase operating efficiency thanks to the appropriate use of intellectual capital. This is to be undertaken while always acting in the interest of the Company and of the companies belonging to the group of companies whose parent company, as established by law, is the Company (the “**Group**”), and without prejudice to specific policies which may be established by specific companies within the Group.

In a world where traditional production assets are increasingly accessible, intellectual capital marks the differences between competitive and non-competitive companies; between companies that create value sustainably and those that are gradually losing their wealth-generating capacity.

The intellectual capital of the Company depends largely on the whole of its personnel, but also on its operational and organisational structures and on its internal and external relationships with all stakeholders. Therefore, learning at the personnel and organisational levels must be permanent, continuous and aligned with the Group's strategy.

The markedly strategic nature which the Company imposes on knowledge management requires constant efforts to improve the initiatives and apply them to all of the Company's business units.

2. Basic principles of action

To achieve the aforementioned objectives, the Group assumes and promotes the following basic principles of action that must preside over all activities in the field of knowledge management:

- a. Consideration of the Group as a system made up of connections between people and working groups. The knowledge existing in each working group should be identifiable and accessible to the whole, thus giving rise to knowledge-based operating leverage.
- b. Recognition of the value of knowledge existing in the Group and promotion of its development as a basic tool for the creation of value.
- c. The integration of the Group's tangible and intangible assets to provide the objective conditions necessary to structure an intelligent organisation capable of constantly learning and innovating.
- d. Alignment of knowledge management and the skills and requirements defined by the Group's strategy.

- e. Definition of the models needed for management, measurement, processes and systems by integrating the vision of different business units to understand and develop the mechanisms for freeing knowledge flows within the existing organisational structure. In this manner, experiences are shared and continuous attention to the organisation's operation as a whole is guaranteed.
- f. Full enhancement of knowledge-sharing within the Group by facilitating the resources needed for its development, internal dissemination through training actions, and efficient use. This shared intelligence is by nature creative and innovative and superior to the simple sum of individual intellectual capacities. Emphasis will be placed on the creation and improvement of organisational connections (networks) and the cohesion of the groups.
- g. Consistent and sustained long-term evaluation of the intellectual capital in the Group to be able to assess the effectiveness of initiatives undertaken under this Knowledge Management Policy, correcting defects and promoting new engagements.
- h. The implementation of improvement actions that bring the Group ever closer to excellence in knowledge management.
- i. Observance in Group knowledge management of the intellectual and industrial property rights of third parties.

3. Knowledge management strategy in the listed subholdings of the Group





The provisions of this *Knowledge Management Policy* under no circumstances prejudice the enhanced autonomy that the Group's listed subholdings enjoy to define their own knowledge management strategy, which must nevertheless be consistent with the principles contained in this *Knowledge Management Policy*.

This *Knowledge Management Policy* was initially approved by the Iberdrola, S.A.'s Board of Directors on 16 December 2008 and was last amended on 15 December 2015.

Public project funding

Some of the projects described in this Report are co-funded by different public administrations, as detailed in the following table (<https://www.iberdrola.com/sostenibilidad/innovacion/nuestros-negocios/financiacion>)

FUNDING PROGRAMME	PROJECTS	FUNDING PROGRAMME	PROJECTS
	COEBEN		SMARTCOX NEWPLAVOL FILTRACIONES [LEAKS] SMARTWIND EES2 TABON TLPWIND WIND CCC
	SPJ		SOST-CO ₂ OCEANLIDER AZIMUT VIDA
	WORK ORDER MANAGER (TSI-020100-2009-581) GIDIN (TSI-020302-2010-68) E-PREVENTION (TSI-020302-2009-80) SMARTSYS (TSI-020100-2009-365) GESCOM (TSI-020100-2009-604) CPD (TSI-020100-2009-471) IMPULSO (TSI-020100-2009-389) DISPENSER (TSI-020302-2010-127) AVANZA EÓLICO (TSI-020100-2010-663)		DESEO
	<ul style="list-style-type: none"> • MEDECOM • ENDS • SASIRE • DALIA • FILTRONUC • ITER Blankets • TBM • TECHNOFUSIÓN • PROCESS BUS • LABCON • ZEBRA MUSSEL • SOLTUBE • INSROCA • ECRIGEN • COEBEN II • DESOX • SIRO • LOWIMPACT FOUNDATION • MIGRES • GTCONTROLFLEX • RESONUC • PREXES • LAYCA • HYDRODEMAND • HYDROSMART 		BEST4VARIOUS UROGALLO BIOENERGY & FIRE PREVENTION CO2 ALGAEFIX BRIO CO2FORMARE
	LIGNOCROP (RTC-2014-1908-3)		BEST4VARIOUS UROGALLO BIOENERGY & FIRE PREVENTION CO2 ALGAEFIX BRIO CO2FORMARE
	ACCIÓN NUCLEAR ACCIÓN GREEN CARS WIND FARM GENERATOR		ICT4SMARTDG RESERVICES ICT4EVEU HIWave
	LIFE 50+ UPGRID REMOURBAN ASSURED CoordiNet ENERXICO HYDROPOWER EUROPE INTENSYS4EU ROMEO PROMOTION		MARTKET4RES

FUNDING PROGRAMME	PROJECTS	FUNDING PROGRAMME	PROJECTS
 <p>SEVENTH FRAMEWORK PROGRAMME</p>	<ul style="list-style-type: none"> • ADDRESS • OPEN-METER • OPEN-NODE • MERGE • GREEN eMOTION • TWENTIES • CAPIRE • INTEG-RISK • ASAMPSA2 • NOZZLEINSPECT • CAPSOL <ul style="list-style-type: none"> • Grid4EU • GRID+ • FINSENY • HESCAP • METER ON • ADVANCED • DTOCEAN • Igreengrid • DISCERNLEAN-WIND • BESTPATHS • SIRBATT 		<p>EFESOT (IPT-120000-2010-22) DEPOLIGEN (IPT-120000-2010-31) EMERGE (IPT-120000-2010-017) EXTRADIS (IPT-120000-2010-037) EXTRASUPER (IPT-120000-2010-038) ATOS SUBS (IPT-120000-2010-039) PRICE-RED (IPT-2011-1504-920000) PRICE-GDE (IPT-2011-1490-920000) PRICE-GEN (IPT-2011-1507-920000) PRICE-GDI (IPT-2011-1501-920000) PROINVER (IPT-2011-1373-920000) SIG-MA (IPT-2011-1137-920000) OpenFOAM (IPT-2011-1693-920000)</p>
 <p>UNIÓN EUROPEA Fondo Europeo de Desarrollo Regional Una manera de hacer Europa</p>	<p>MATUSALEN (RTC-2014-1908-3) HIDRASENSE (RTC-2014-2232-3) SILECTRIC-LL (RTC-2014-3147-3) OCTAVE (RTC-2016-4845-3) OPD (RTC-2016-5160-3) ALOIS (RTC-2017-6296-3) DOCTOR-PV (RTC-2017-6712-3) EPESOL (RTC-2017-6291-3)</p>	 <p>EUSKO JAURLARITZA GOBIERNO VASCO EMPLUETZA GEARITE POLITIKAREN ARLOA DEPARTAMENTO DE EMPLEO Y POLÍTICAS SOCIALES</p>	<ul style="list-style-type: none"> • MUGIELEC • FLOTTEK • ARIADNA EDCI • SIREN • SAREBAT • SUARO II • H2SAI2 • SAGERII • PLIDII • DIBADIS • SIRENAII • UHINDAR • MARINEL • ESStoZEB • AZKARGA • SAMARIA • SAGER III • ITSASERAUPEN • mGridSTORAGE • Flow
 <p>Co-financed by the Connecting Europe Facility of the European Union</p>	<p>CIRVE</p>		

